

AIR CONDITIONER

Duct type

DESIGN & TECHNICAL MANUAL

INDOOR



ADUH09LUAS1
ADUH12LUAS1



ADUH18LUAS1

OUTDOOR



AOUH09LUAS1



AOUH12LUAS1
AOUH18LUAS1

FUJITSU GENERAL LIMITED

Notices:

- Product specifications and design are subject to change without notice for future improvement.
- For further details, please check with our authorized dealer.

Trademarks

FGLair™ is trademark of Fujitsu General Limited in the United States, other countries or both.

Google Play™ is trademark of Google Inc.

App Store® is a service mark of Apple Inc., registered in the U.S. and other countries.

CONTENTS

Part 1. INDOOR UNIT	1
1. Specifications	2
2. Dimensions	4
2-1. Models: ADUH09LUAS1 and ADUH12LUAS1	4
2-2. Model: ADUH18LUAS1.....	5
2-3. Installation space requirement	6
2-4. Maintenance space requirement.....	7
3. Wiring diagrams	8
3-1. Models: ADUH09LUAS1, ADUH12LUAS1, and ADUH18LUAS1	8
4. Capacity table	9
4-1. Cooling capacity.....	9
4-2. Heating capacity	11
5. Fan performance	13
5-1. Air velocity and temperature distributions	13
5-2. Fan performance curve.....	19
5-3. Airflow.....	25
6. Operation noise (sound pressure)	28
6-1. Noise level curve.....	28
6-2. Sound level check point	30
7. Safety devices	31
8. External input and output	32
8-1. External input.....	32
8-2. External output.....	34
8-3. Combination of external input and output.....	36
8-4. Details of function	39
9. Function settings	64
9-1. Function settings on indoor unit	64
9-2. Function settings by using remote controller.....	66
10. Accessories	74
10-1. Models: ADUH09LUAS1, ADUH12LUAS1, and ADUH18LUAS1	74
11. Optional parts	75
11-1. Controllers	75
11-2. Others.....	76

CONTENTS (continued)

Part 2. OUTDOOR UNIT	79
1. Specifications	80
2. Dimensions	81
2-1. Models: AOUH09LUAS1	81
2-2. Models: AOUH12LUAS1 and AOUH18LUAS1	82
3. Installation space	83
3-1. Models: AOUH09LUAS1, AOUH12LUAS1, and AOUH18LUAS1	83
4. Refrigerant circuit	86
4-1. Models: AOUH09LUAS1	86
4-2. Models: AOUH12LUAS1 and AOUH18LUAS1	87
5. Wiring diagrams	88
5-1. Model: AOUH09LUAS1	88
5-2. Models: AOUH12LUAS1 and AOUH18LUAS1	89
6. Capacity compensation rate for pipe length and height difference	90
6-1. Model: AOUH09LUAS1	90
6-2. Model: AOUH12LUAS1	91
6-3. Model: AOUH18LUAS1	92
7. Additional charge calculation	93
7-1. Model: AOUH09LUAS1	93
7-2. Model: AOUH12LUAS1	93
7-3. Model: AOUH18LUAS1	93
8. Airflow	94
8-1. Model: AOUH09LUAS1	94
8-2. Model: AOUH12LUAS1	94
8-3. Model: AOUH18LUAS1	95
9. Operation noise (sound pressure)	96
9-1. Noise level curve.....	96
9-2. Sound level check point	97
10. Electrical characteristics	98
11. Safety devices	99
12. Accessories	100
12-1.Models: AOUH09LUAS1, AOUH12LUAS1, and AOUH18LUAS1	100

Part 1. INDOOR UNIT

DUCT TYPE:

ADUH09LUAS1

ADUH12LUAS1

ADUH18LUAS1

1. Specifications

Type				Duct					
				Inverter heat pump					
Model name				ADUH09LUAS1	ADUH12LUAS1	ADUH18LUAS1			
Power supply				208/230 V ~ 60 Hz					
Available voltage range				187—253 V					
Capacity	Cooling	Rated		kW	2.64	3.52	5.02		
			Btu/h	9,000	12,000	17,100			
		Min.—Max.		kW	0.90—3.20	0.90—4.00	0.90—5.90		
			Btu/h	3,100—11,000	3,100—13,600	3,100—20,100			
	Heating	47 °FDB (Outdoor temp.)	Rated		kW	3.52	4.69	6.33	
				Btu/h	12,000	16,000	21,600		
			Min.—Max.		kW	0.90—4.70	0.90—5.70	0.90—7.50	
		Btu/h		3,100—16,000	3,100—19,400	3,100—25,600			
		17 °FDB (Outdoor temp.)	Rated		kW	2.17	3.08	4.22	
				Btu/h	7,400	10,500	14,400		
Max.			kW	3.08	4.98	5.75			
Btu/h	10,500	17,000	19,600						
Input power	Cooling	Rated		kW	0.66	0.94	1.37		
		Max.			1.05	2.06	2.05		
	Heating	47 °FDB (Outdoor temp.)	Rated		0.89	1.30	1.71		
			Max.		1.89	1.79	2.57		
		17 °FDB (Outdoor temp.)	Rated		0.78	1.07	1.49		
			Max.		1.42	2.01	2.56		
	Current	Cooling	Rated		A	3.3	4.2	6.1	
		Heating				4.5	5.8	7.6	
EER	Cooling			kW/kW	4.00	3.74	3.66		
				Btu/hW	13.6	12.8	12.5		
COP	Heating			kW/kW	3.96	3.60	3.70		
				Btu/hW	13.5	12.3	12.6		
SEER	Cooling			Btu/hW	20.0	20.2	20.2		
HSPF	Heating			Btu/hW	11.7	11.5	11.4		
Power factor	Cooling			%	87.0	97.3	97.6		
	Heating				86.0	97.5	97.8		
Moisture removal				pints/h (L/h)	1.5 (0.7)	2.7 (1.3)	4.2 (2.0)		
Maximum operating current *1	Cooling			A	6.8	9.8	11.8		
	Heating				9.3	11.3	14.8		
Fan	Airflow rate	Cooling	HIGH	CFM (m ³ /h)	353 (600)	383 (650)	553 (940)		
			MED		324 (550)	353 (600)	518 (880)		
			LOW		294 (500)	324 (550)	482 (820)		
			QUIET		265 (450)	283 (480)	441 (750)		
		Heating	HIGH		353 (600)	383 (650)	553 (940)		
			MED		324 (550)	353 (600)	518 (880)		
			LOW		294 (500)	324 (550)	482 (820)		
			QUIET		265 (450)	283 (480)	441 (750)		
			Type × Q'ty				Sirocco × 2	Sirocco × 3	
			Motor output		W		81		
Recommended static pressure				inWG (Pa)	0 to 0.36 (0 to 90)				
Sound pressure level *2	Cooling	HIGH	dB (A)	28	29	32			
		MED		27	28	30			
		LOW		26	27	29			
		QUIET		25	26	27			
	Heating	HIGH		28	29	32			
		MED		26	28	30			
		LOW		25	27	29			
		QUIET		24	24	27			
		Heat exchanger type		Dimensions (H × W × D)		in (mm)	294 × 500 × 39.9		294 × 700 × 39.9
				Fin pitch		FPI	1.3		
Rows × Stages			3 × 14						
Pipe type			Copper tube						
Fin type			Aluminum						
Enclosure		Material		Steel sheet					
Color		—							
Dimensions (H × W × D)	Net			in (mm)	7-13/16 × 27-9/16 × 24-7/16 (198 × 700 × 620)		7-13/16 × 35-7/16 × 24-7/16 (198 × 900 × 620)		
	Gross				10-7/8 × 38-1/8 × 30-3/8 (276 × 968 × 772)		10-7/8 × 46 × 30-3/8 (276 × 1,168 × 772)		
Weight	Net			lb (kg)	37 (17)		44 (20)		
	Gross				49 (22)		57 (26)		
Connection pipe	Size	Liquid			Ø1/4 (Ø6.35)				
	Method	Gas			Ø3/8 (Ø9.52)		Ø1/2 (Ø12.70)		
Operation range	Cooling			°F (°C)	64 to 90 (18 to 32)				
				%RH	80 or less				
	Heating			°F (°C)	60 to 86 (16 to 30)				
Drain hose	Material		HARD PVC						
	Size			in (mm)	Ø3/4 (Ø20.7) [I.D.] Ø1-1/16 (Ø26.6) [O.D.]				

Type	Duct		
	Inverter heat pump		
Model name	ADUH09LUAS1	ADUH12LUAS1	ADUH18LUAS1
<p>NOTES:</p> <ul style="list-style-type: none"> • Specifications are based on the following conditions: <ul style="list-style-type: none"> – Cooling: Indoor temperature of 80 °FDB/67 °FWB(26.67 °CDB/19.44 °CWB), and outdoor temperature of 95 °FDB/75 °FWB (35 °CDB/23.9 °CWB). – Heating: Indoor temperature of 70 °FDB/59 °FWB (21.11 °CDB/15 °CWB), and outdoor temperature of 47 °FDB /43 °FWB (8.33 °CDB/6.11°CWB). – Standard static pressure: 0.10 inWG (25 Pa) – Pipe length: 24 ft 7 in (7.5 m), Height difference: 0 m. (Between outdoor unit and indoor unit.) • Protective function might work when using it outside the operation range. • *1: Maximum current: <ul style="list-style-type: none"> – The maximum value when operated within the operation range. – The total current of indoor unit and outdoor unit. • *2: Sound pressure level: <ul style="list-style-type: none"> – Measured values in manufacturer's anechoic chamber. – Because of the surrounding sound environment, the sound levels measured in actual installation conditions might be higher than the specified values here. • *3: Available on Google Play™ store or on App Store®. Optional WLAN adapter is also required. For details, refer to the setting manual. 			

2. Dimensions

2-1. Models: ADUH09LUAS1 and ADUH12LUAS1

Unit: in (mm)

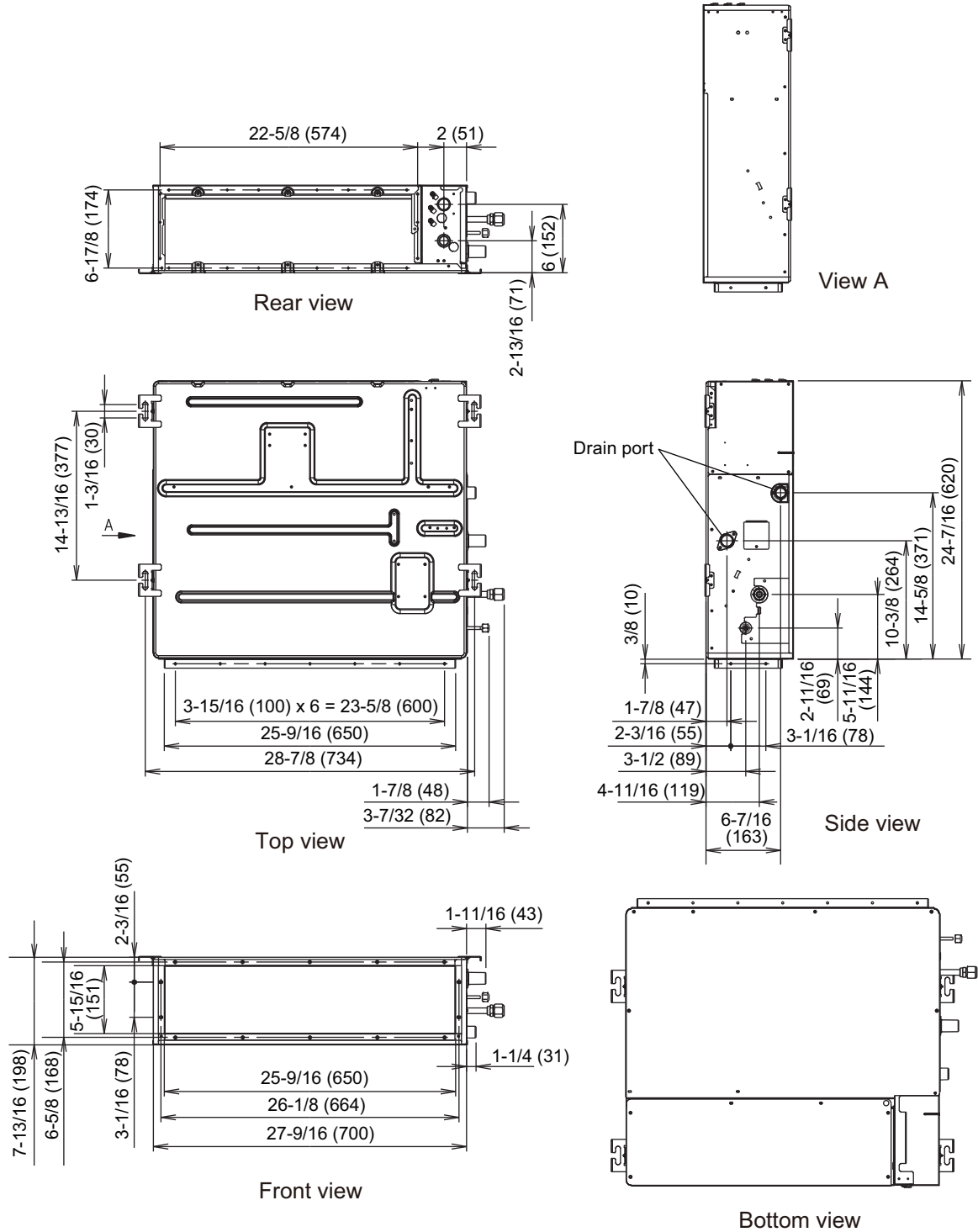

2-2. Model: ADUH18LUAS1

Unit: in (mm)

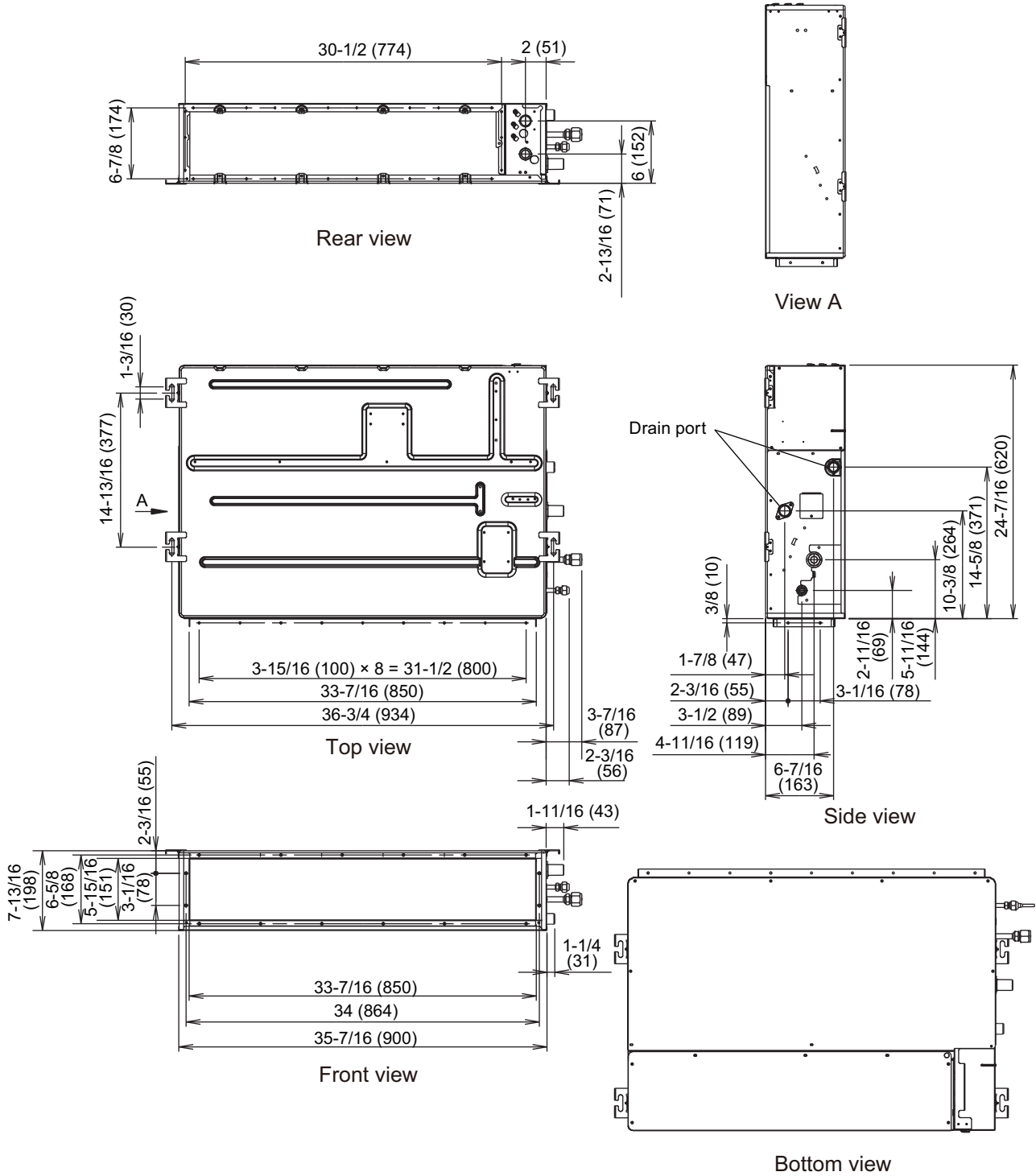

2-3. Installation space requirement

Provide sufficient installation space for product safety.

In ceiling-concealed installations:

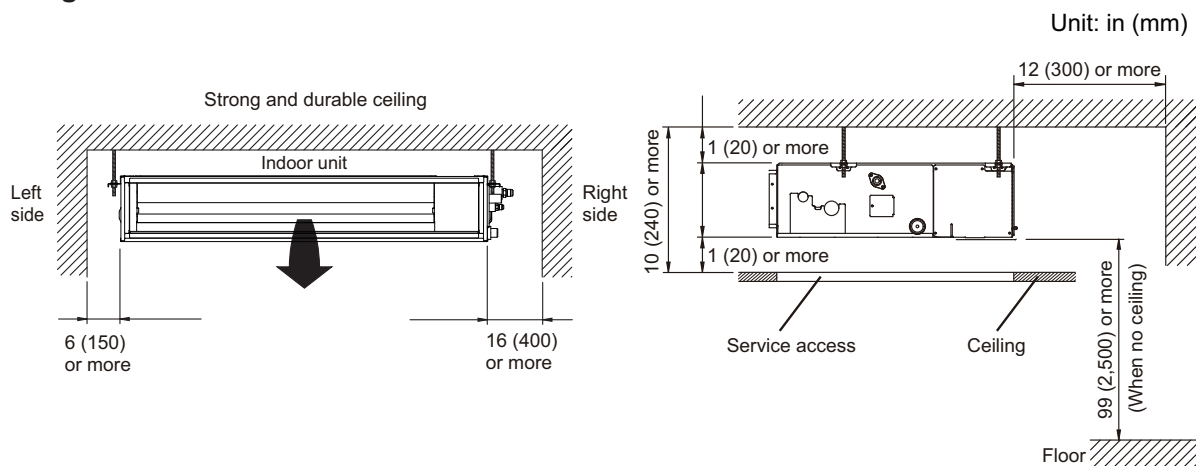

In wall-concealed installations:

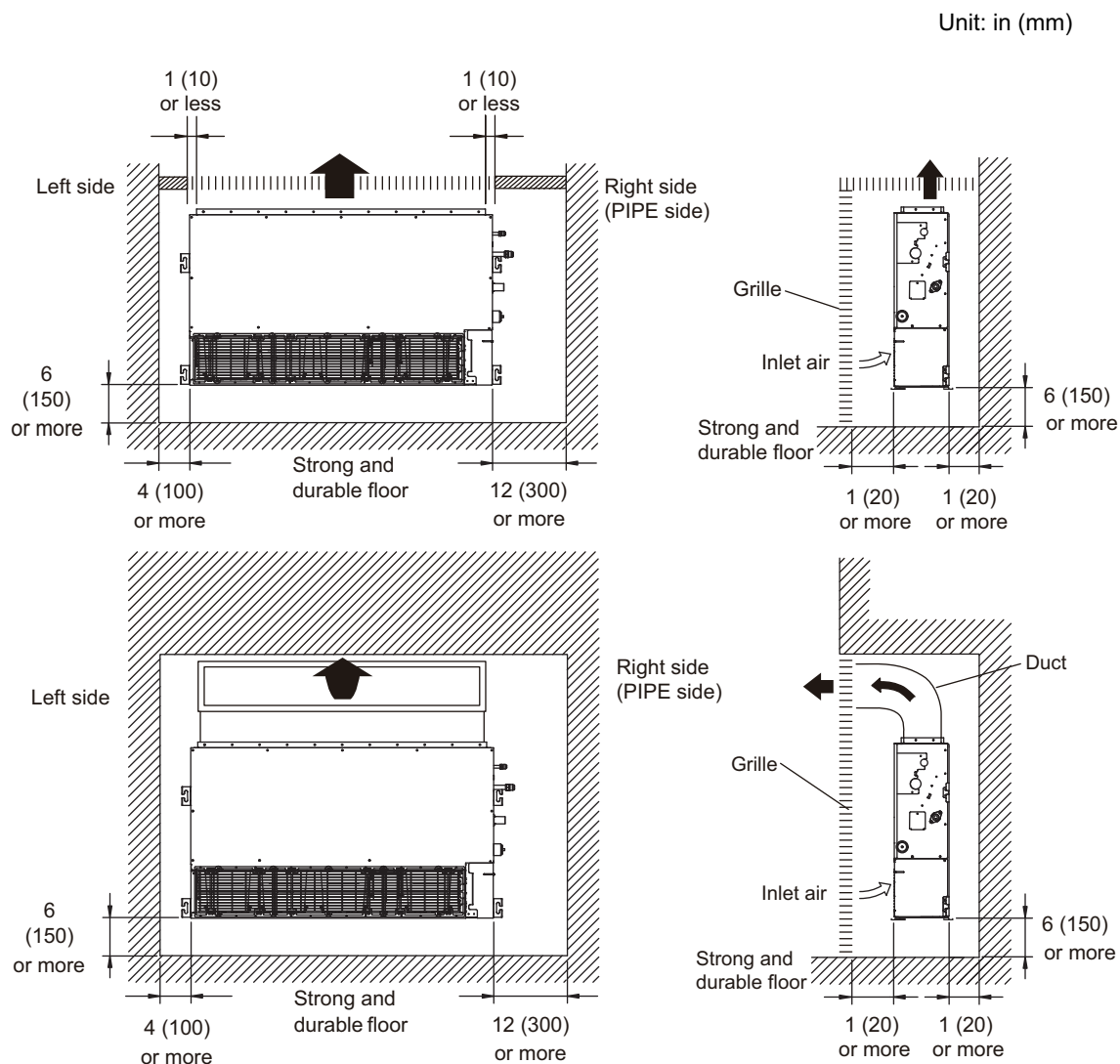

2-4. Maintenance space requirement

For future maintenance and service access, provide sufficient maintenance space.

NOTE: Do not place any wiring or illumination in the maintenance space, as they will impede service.

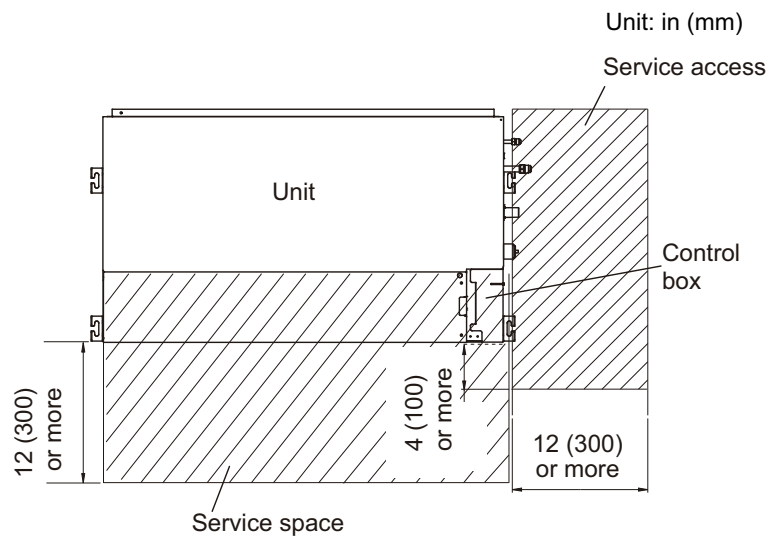

3. Wiring diagrams

3-1. Models: ADUH09LUAS1, ADUH12LUAS1, and ADUH18LUAS1

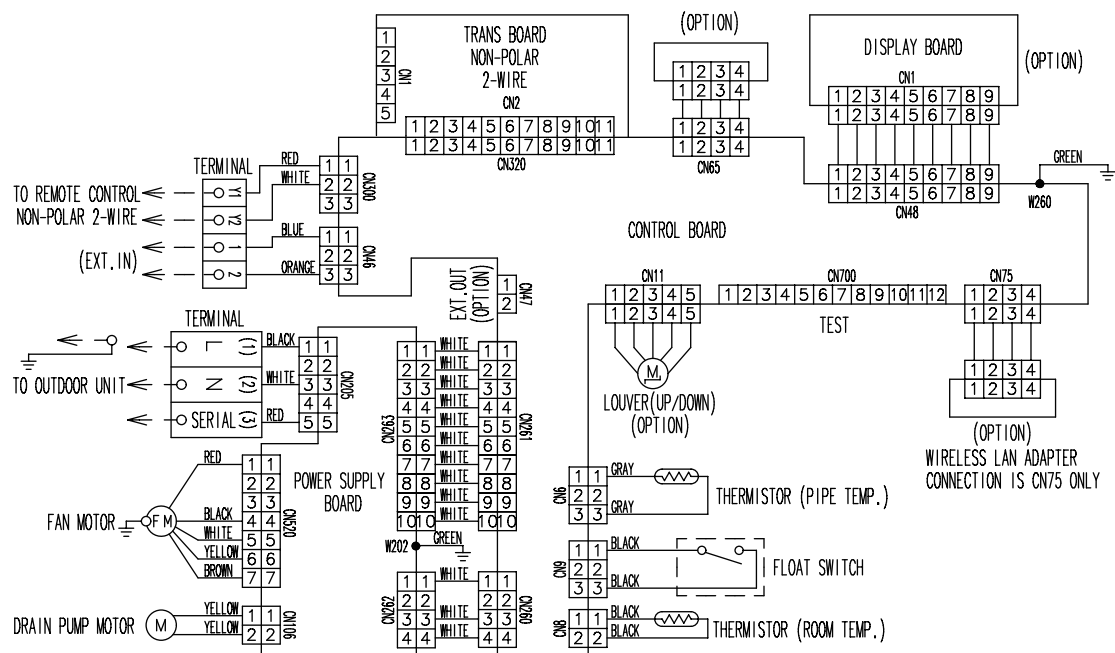

4. Capacity table

Capacity tables show each of following values calculated based on the outdoor temperature and the indoor temperature, under given Airflow Rate (AFR):

For cooling capacity: Total Capacity (TC), Sensible Heat Capacity (SHC), and Input Power (IP)

For heating capacity: Total Capacity (TC) and Input Power (IP)

4-1. Cooling capacity

■ Model: ADUH09LUAS1

AFR	CFM	353
-----	-----	-----

Outdoor temperature	Indoor temperature																							
	°FDB	64						70				75				80			85			90		
	°FWB	54						60				63				67			71			73		
	°FDB	TC	SHC	IP	TC	SHC	IP	TC	SHC	IP	TC	SHC	IP	TC	SHC	IP	TC	SHC	IP					
		kBtu/h		kW	kBtu/h		kW	kBtu/h		kW	kBtu/h		kW	kBtu/h		kW	kBtu/h		kW					
14	8.43	6.91	0.23	9.39	6.95	0.23	9.71	7.55	0.23	10.67	8.18	0.23	11.31	8.15	0.24	11.95	8.68	0.24	11.95	8.68	0.24			
23	7.99	6.55	0.26	8.90	6.59	0.26	9.21	7.16	0.26	10.12	7.76	0.27	10.72	7.73	0.27	11.33	8.23	0.27	11.33	8.23	0.27			
32	7.55	6.18	0.27	8.41	6.22	0.28	8.70	6.76	0.28	9.56	7.33	0.28	10.13	7.30	0.28	10.70	7.77	0.29	10.70	7.77	0.29			
41	7.47	5.82	0.27	8.32	5.86	0.28	8.60	6.37	0.28	9.45	6.90	0.28	10.02	6.87	0.28	10.58	7.32	0.29	10.58	7.32	0.29			
50	7.67	5.46	0.27	8.54	5.50	0.27	8.83	5.98	0.27	9.70	6.48	0.28	10.29	6.45	0.28	10.87	6.87	0.28	10.87	6.87	0.28			
59	7.16	5.28	0.28	7.98	5.31	0.28	8.25	5.78	0.28	9.06	6.26	0.29	9.61	6.23	0.29	10.15	6.64	0.29	10.15	6.64	0.29			
67	8.57	6.22	0.45	9.55	6.25	0.46	9.88	6.80	0.46	10.85	7.37	0.47	11.50	7.34	0.47	12.15	7.82	0.48	12.15	7.82	0.48			
77	8.11	5.95	0.51	9.03	5.99	0.52	9.34	6.51	0.52	10.26	7.05	0.53	10.88	7.02	0.53	11.49	7.48	0.54	11.49	7.48	0.54			
87	7.58	5.83	0.58	8.45	5.87	0.59	8.74	6.38	0.60	9.60	6.91	0.61	10.18	6.88	0.61	10.75	7.33	0.62	10.75	7.33	0.62			
95	7.11	5.57	0.64	7.92	5.60	0.65	8.19	6.09	0.65	9.00	6.60	0.66	9.54	6.57	0.67	10.08	7.00	0.67	10.08	7.00	0.67			
104	6.04	5.28	0.60	6.73	5.31	0.61	6.96	5.78	0.62	7.65	6.26	0.63	8.11	6.23	0.63	8.57	6.64	0.64	8.57	6.64	0.64			
115	5.55	5.24	0.51	6.19	5.27	0.52	6.40	5.73	0.52	7.03	6.21	0.53	7.45	6.19	0.54	7.87	6.59	0.54	7.87	6.59	0.54			

AFR	m ³ /h	600
-----	-------------------	-----

Outdoor temperature	Indoor temperature																							
	°CDB	17.8						21.1				23.9				26.7			29.4			32.2		
	°CWB	12.2						15.6				17.2				19.4			21.7			22.8		
	°CDB	TC	SHC	IP	TC	SHC	IP	TC	SHC	IP	TC	SHC	IP	TC	SHC	IP	TC	SHC	IP					
		kW		kW	kW		kW	kW		kW	kW		kW	kW		kW	kW		kW					
-10.0	2.47	2.02	0.23	2.75	2.04	0.23	2.85	2.21	0.23	3.13	2.40	0.23	3.32	2.39	0.24	3.50	2.55	0.24	3.50	2.55	0.24			
-5.0	2.34	1.92	0.26	2.61	1.93	0.26	2.70	2.10	0.26	2.97	2.27	0.27	3.14	2.27	0.27	3.32	2.41	0.27	3.32	2.41	0.27			
0.0	2.21	1.81	0.27	2.47	1.82	0.28	2.55	1.98	0.28	2.80	2.15	0.28	2.97	2.14	0.28	3.14	2.28	0.29	3.14	2.28	0.29			
5.0	2.19	1.71	0.27	2.44	1.72	0.28	2.52	1.87	0.28	2.77	2.02	0.28	2.94	2.01	0.28	3.10	2.15	0.29	3.10	2.15	0.29			
10.0	2.25	1.60	0.27	2.50	1.61	0.27	2.59	1.75	0.27	2.84	1.90	0.28	3.02	1.89	0.28	3.19	2.01	0.28	3.19	2.01	0.28			
15.0	2.10	1.55	0.28	2.34	1.56	0.28	2.42	1.69	0.28	2.66	1.83	0.29	2.82	1.83	0.29	2.98	1.95	0.29	2.98	1.95	0.29			
19.4	2.51	1.82	0.45	2.80	1.83	0.46	2.90	1.99	0.46	3.18	2.16	0.47	3.37	2.15	0.47	3.56	2.29	0.48	3.56	2.29	0.48			
25.0	2.38	1.74	0.51	2.65	1.75	0.52	2.74	1.91	0.52	3.01	2.07	0.53	3.19	2.06	0.53	3.37	2.19	0.54	3.37	2.19	0.54			
30.6	2.22	1.71	0.58	2.48	1.72	0.59	2.56	1.87	0.60	2.81	2.03	0.61	2.98	2.02	0.61	3.15	2.15	0.62	3.15	2.15	0.62			
35.0	2.08	1.63	0.64	2.32	1.64	0.65	2.40	1.79	0.65	2.64	1.93	0.66	2.80	1.93	0.67	2.96	2.05	0.67	2.96	2.05	0.67			
40.0	1.77	1.55	0.60	1.97	1.56	0.61	2.04	1.69	0.62	2.24	1.83	0.63	2.38	1.83	0.63	2.51	1.95	0.64	2.51	1.95	0.64			
46.0	1.63	1.54	0.47	1.81	1.55	0.48	1.88	1.68	0.48	2.06	1.82	0.49	2.18	1.81	0.49	2.31	1.93	0.50	2.31	1.93	0.50			

4-2. Heating capacity

■ Model: ADUH09LUAS1

AFR	CFM	353
-----	-----	-----

Outdoor temperature		Indoor temperature									
		°FDB		60		65		70		75	
		°FDB	°FWB	TC	IP	TC	IP	TC	IP	TC	IP
				kBtu/h	kW	kBtu/h	kW	kBtu/h	kW	kBtu/h	kW
-5	-7	8.96	1.18	8.74	1.21	8.53	1.23	8.10	1.28		
5	3	10.63	1.28	10.37	1.30	10.12	1.33	9.61	1.38		
14	12	10.47	1.31	10.22	1.33	9.97	1.36	9.47	1.41		
23	19	12.32	1.38	12.02	1.41	11.73	1.44	11.14	1.50		
32	28	13.99	1.49	13.65	1.52	13.32	1.55	12.65	1.61		
41	37	15.49	1.79	15.12	1.83	14.75	1.87	14.01	1.94		
47	43	16.80	1.81	16.40	1.85	16.00	1.89	15.20	1.97		
50	47	16.89	1.84	16.49	1.87	16.09	1.91	15.29	1.98		
59	50	17.06	1.73	16.66	1.76	16.25	1.80	15.44	1.86		
68	59	16.10	1.19	15.79	1.22	15.33	1.24	14.56	1.29		
75	64	16.62	1.25	16.30	1.27	15.83	1.30	15.04	1.35		

AFR	m ³ /h	600
-----	-------------------	-----

Outdoor temperature		Indoor temperature									
		°CDB		15.6		18.3		21.1		23.9	
		°CDB	°CWB	TC	IP	TC	IP	TC	IP	TC	IP
				kW		kW		kW		kW	
-20.6	-21.7	2.63	1.20	2.56	1.23	2.50	1.25	2.38	1.30		
-15.0	-16.1	3.11	1.23	3.04	1.25	2.97	1.28	2.82	1.33		
-10.0	-11.1	3.07	1.31	3.00	1.33	2.92	1.36	2.78	1.41		
-5.0	-7.2	3.61	1.38	3.52	1.41	3.44	1.44	3.27	1.50		
0.0	-2.2	4.10	1.49	4.00	1.52	3.90	1.55	3.71	1.61		
5.0	2.8	4.54	1.58	4.43	1.62	4.32	1.65	4.11	1.72		
8.3	6.1	4.92	1.60	4.81	1.64	4.69	1.67	4.45	1.74		
10.0	8.3	4.95	1.62	4.83	1.66	4.72	1.69	4.48	1.75		
15.0	10.0	5.00	1.53	4.88	1.56	4.76	1.59	4.52	1.65		
20.0	15.0	4.72	1.19	4.63	1.22	4.49	1.24	4.27	1.29		
24.0	18.0	4.87	1.25	4.78	1.27	4.64	1.30	4.41	1.35		

■ Model: ADUH12LUAS1

AFR	CFM	383
-----	-----	-----

Outdoor temperature		Indoor temperature									
		°FDB		60		65		70		75	
		°FDB	°FWB	TC	IP	TC	IP	TC	IP	TC	IP
				kBtu/h	kW	kBtu/h	kW	kBtu/h	kW	kBtu/h	kW
-5	-7	15.75	2.11	15.38	2.16	15.00	2.20	14.25	2.29		
5	3	16.80	2.16	16.40	2.21	16.00	2.25	15.20	2.34		
14	12	18.27	2.04	17.84	2.08	17.40	2.12	16.53	2.20		
23	19	19.11	1.87	18.66	1.91	18.20	1.95	17.29	2.03		
32	28	19.43	1.82	18.96	1.86	18.50	1.90	17.58	1.98		
41	37	19.74	1.77	19.27	1.81	18.80	1.84	17.86	1.92		
47	43	20.37	1.72	19.89	1.75	19.40	1.79	18.43	1.86		
50	47	22.47	1.71	21.94	1.75	21.40	1.78	20.33	1.84		
59	50	23.31	1.51	22.76	1.55	22.20	1.58	21.09	1.63		
68	59	22.14	1.21	21.72	1.24	21.09	1.26	20.04	1.31		
75	64	22.61	1.24	22.18	1.27	21.53	1.29	20.46	1.35		

AFR	m ³ /h	650
-----	-------------------	-----

Outdoor temperature		Indoor temperature									
		°CDB		15.6		18.3		21.1		23.9	
		°CDB	°CWB	TC	IP	TC	IP	TC	IP	TC	IP
				kW		kW		kW		kW	
-20.6	-21.7	4.62	1.20	4.51	1.23	4.40	1.25	4.18	1.30		
-15.0	-16.1	4.92	1.23	4.81	1.25	4.69	1.28	4.45	1.33		
-10.0	-11.1	5.35	1.31	5.23	1.33	5.10	1.36	4.84	1.41		
-5.0	-7.2	5.60	1.38	5.47	1.41	5.33	1.44	5.07	1.50		
0.0	-2.2	5.69	1.49	5.56	1.52	5.42	1.55	5.15	1.61		
5.0	2.8	5.79	1.58	5.65	1.62	5.51	1.65	5.23	1.72		
8.3	6.1	5.97	1.60	5.83	1.64	5.69	1.67	5.40	1.74		
10.0	8.3	6.59	1.62	6.43	1.66	6.27	1.69	5.96	1.75		
15.0	10.0	6.83	1.53	6.67	1.56	6.51	1.59	6.18	1.65		
20.0	15.0	6.49	1.19	6.37	1.22	6.18	1.24	5.87	1.29		
24.0	18.0	6.63	1.25	6.50	1.27	6.31	1.30	6.00	1.35		

Model: ADUH18LUAS1

AFR	CFM	553
-----	-----	-----

		°FDB	Indoor temperature								
			°FWB	60		65		70		75	
				TC	IP	TC	IP	TC	IP	TC	IP
Outdoor temperature	°FDB	°FWB	kBtu/h	kW	kBtu/h	kW	kBtu/h	kW	kBtu/h	kW	
	-5	-7	15.75	2.02	15.38	2.06	15.00	2.10	14.25	2.18	
	5	3	18.38	2.11	17.94	2.16	17.50	2.20	16.63	2.29	
	14	12	19.95	2.36	19.48	2.41	19.00	2.46	18.05	2.56	
	23	19	21.11	2.60	20.60	2.66	20.10	2.71	19.10	2.82	
	32	28	22.85	2.92	22.30	2.98	21.76	3.04	20.67	3.16	
	41	37	25.11	2.60	24.51	2.66	23.91	2.71	22.72	2.82	
	47	43	26.88	2.50	26.24	2.55	25.60	2.60	24.32	2.70	
	50	47	28.00	2.34	27.34	2.39	26.67	2.43	25.34	2.52	
	59	50	29.13	2.07	28.44	2.12	27.74	2.16	26.36	2.24	
	68	59	27.67	1.66	27.15	1.69	26.36	1.73	25.04	1.80	
	75	64	28.26	1.70	27.72	1.74	26.91	1.77	25.56	1.84	

AFR	m ³ /h	940
-----	-------------------	-----

		°CDB	Indoor temperature								
			°CWB	15.6		18.3		21.1		23.9	
				TC	IP	TC	IP	TC	IP	TC	IP
Outdoor temperature	°CDB	°CWB	kW		kW		kW		kW		
	-20.6	-21.7	4.62	1.20	4.51	1.23	4.40	1.25	4.18	1.30	
	-15.0	-16.1	5.39	1.23	5.26	1.25	5.13	1.28	4.87	1.33	
	-10.0	-11.1	5.85	1.31	5.71	1.33	5.57	1.36	5.29	1.41	
	-5.0	-7.2	6.19	1.38	6.04	1.41	5.89	1.44	5.60	1.50	
	0.0	-2.2	6.70	1.49	6.54	1.52	6.38	1.55	6.06	1.61	
	5.0	2.8	7.36	1.58	7.18	1.62	7.01	1.65	6.66	1.72	
	8.3	6.1	7.88	1.60	7.69	1.64	7.50	1.67	7.13	1.74	
	10.0	8.3	8.21	1.62	8.01	1.66	7.82	1.69	7.43	1.75	
	15.0	10.0	8.54	1.53	8.33	1.56	8.13	1.59	7.72	1.65	
	20.0	15.0	8.11	1.19	7.96	1.22	7.72	1.24	7.34	1.29	
	24.0	18.0	8.28	1.25	8.12	1.27	7.89	1.30	7.49	1.35	

5. Fan performance

NOTE: Airflow and capacity/outlet temperature curve data are measured based on the same conditions mentioned in "Specifications".

5-1. Air velocity and temperature distributions

■ Model: ADUH09LUAS1

NOTE: This data is measured after installing optional Auto louver grille kit.

Measuring conditions	Fan speed	Operation mode
	HIGH	FAN

- Air velocity distribution

Top view
Vertical airflow direction louver: Up
Horizontal airflow direction louver: Center

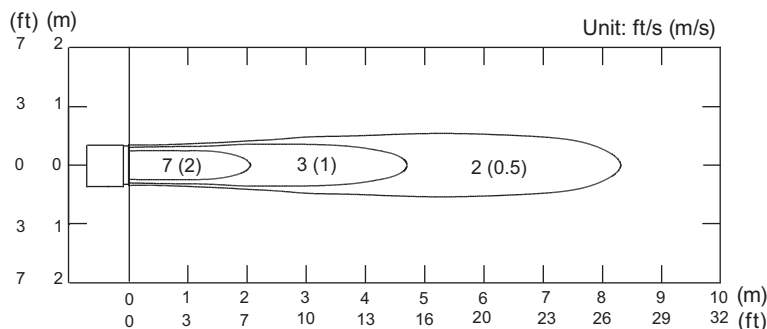

Top view
Vertical airflow direction louver: Up
Horizontal airflow direction louver: Left & Right

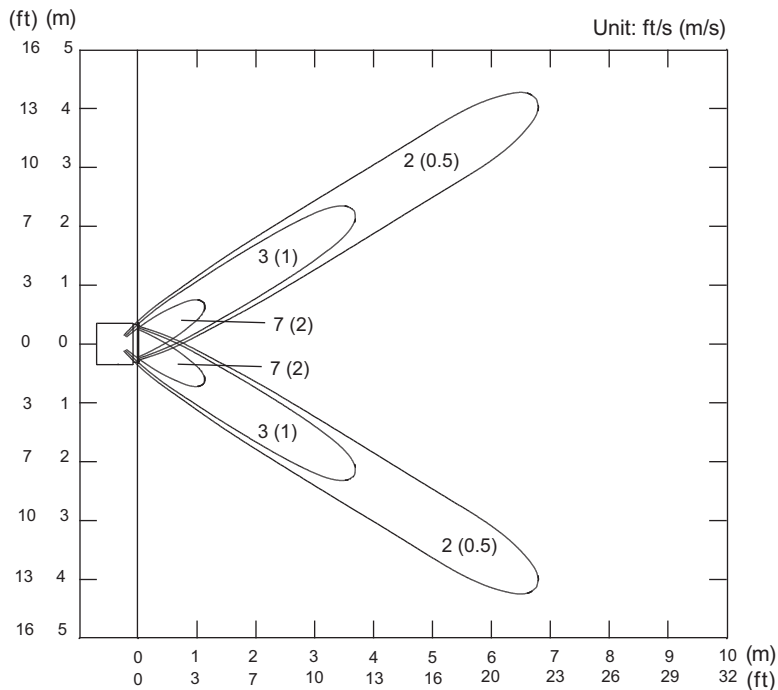

Side view
Vertical airflow direction louver: Up
Horizontal airflow direction louver: Center

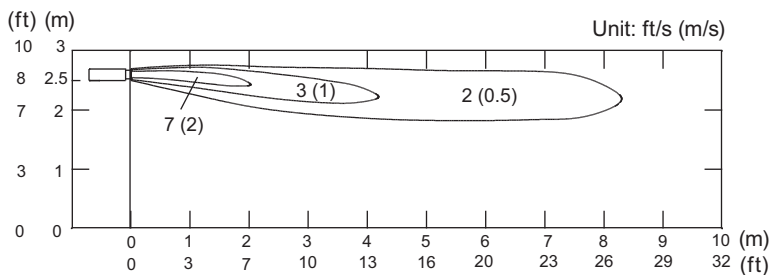

Measuring conditions	Fan speed	Operation mode
	HIGH	HEAT

• Air velocity distribution

Side view
Vertical airflow direction louver: Down
Horizontal airflow direction louver: Center

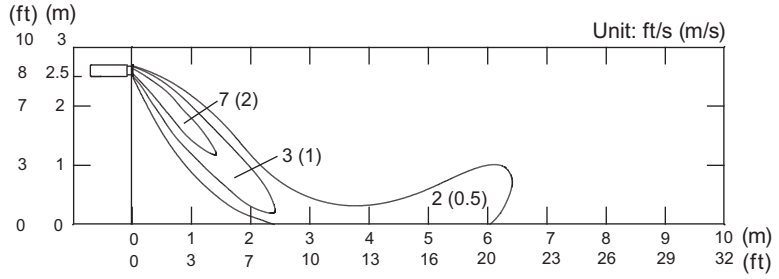

• Air temperature distribution

Side view
Vertical airflow direction louver: Down
Horizontal airflow direction louver: Center

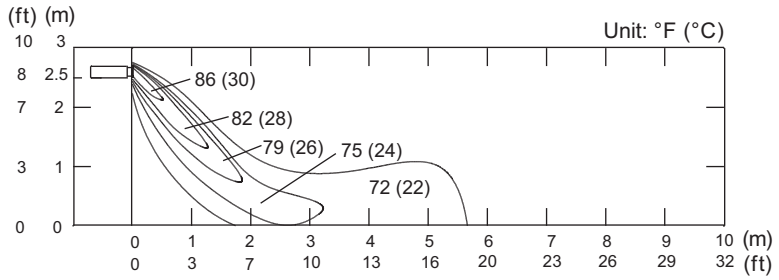

Model: ADUH12LUAS1

NOTE: This data is measured after installing optional Auto louver grille kit.

Measuring conditions	Fan speed	Operation mode
	HIGH	FAN

- Air velocity distribution

Top view
Vertical airflow direction louver: Up
Horizontal airflow direction louver: Center

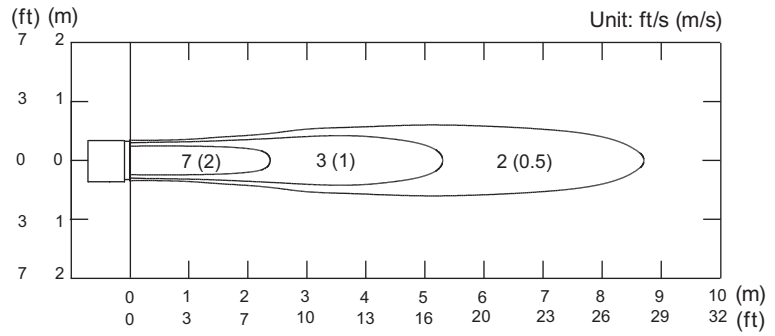

Top view
Vertical airflow direction louver: Up
Horizontal airflow direction louver: Left & Right

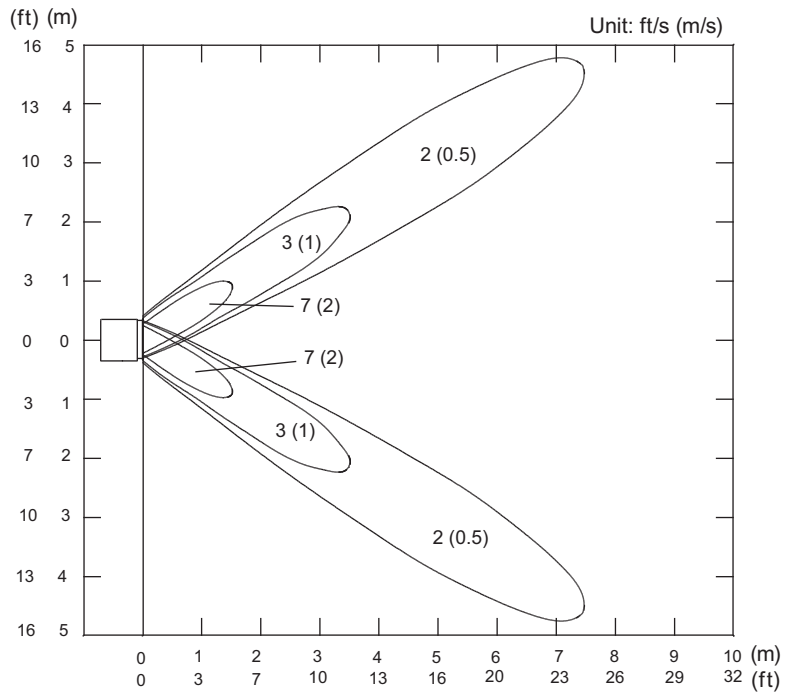

Side view
Vertical airflow direction louver: Up
Horizontal airflow direction louver: Center

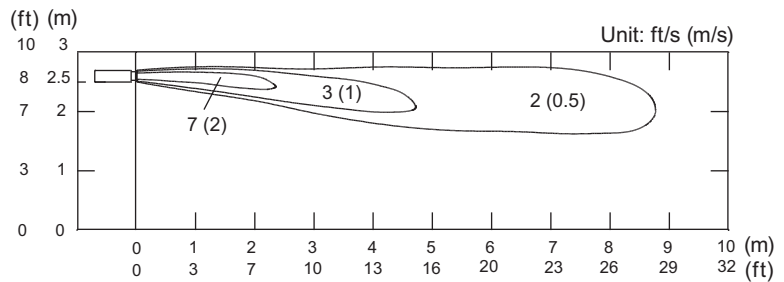

Measuring conditions	Fan speed	Operation mode
	HIGH	HEAT

• Air velocity distribution

Side view
Vertical airflow direction louver: Down
Horizontal airflow direction louver: Center

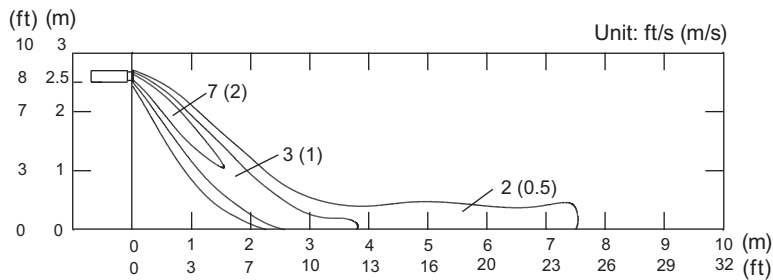

• Air temperature distribution

Side view
Vertical airflow direction louver: Down
Horizontal airflow direction louver: Center

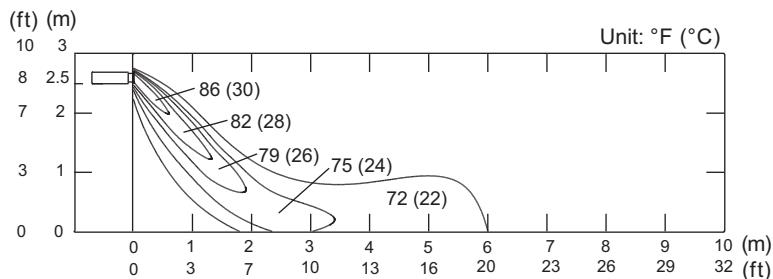

Model: ADUH18LUAS1

NOTE: This data is measured after installing optional Auto louver grille kit.

Measuring conditions	Fan speed	Operation mode
	HIGH	FAN

- Air velocity distribution

Top view
Vertical airflow direction louver: Up
Horizontal airflow direction louver: Center

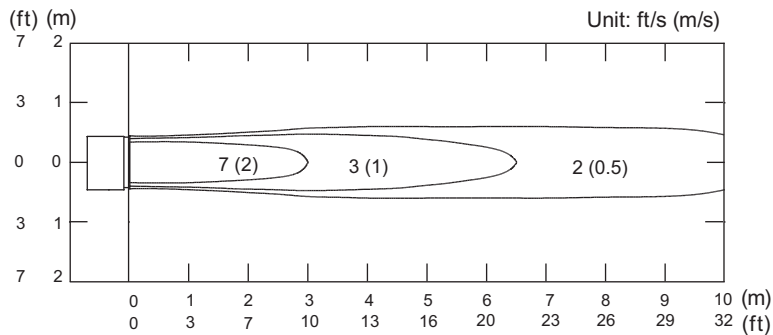

Top view
Vertical airflow direction louver: Up
Horizontal airflow direction louver: Left & Right

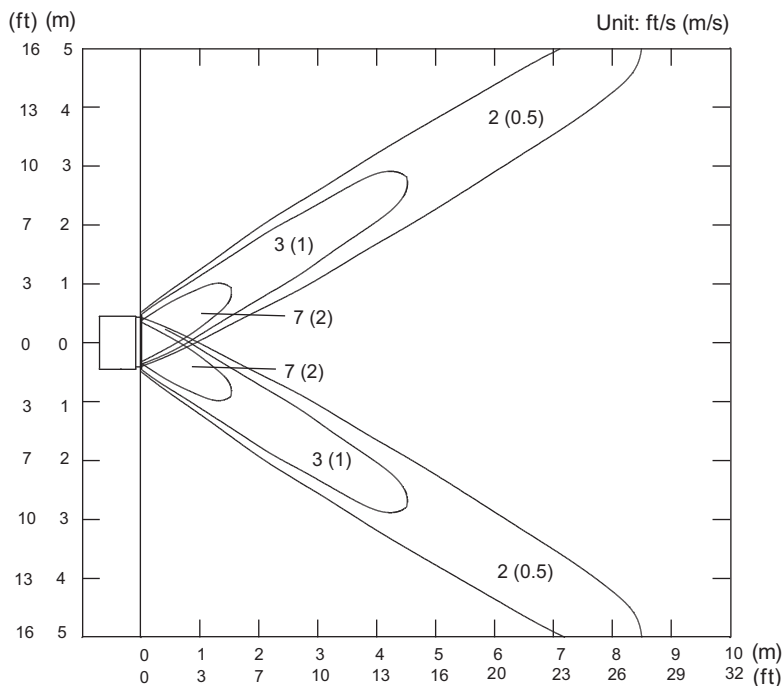

Side view
Vertical airflow direction louver: Up
Horizontal airflow direction louver: Center

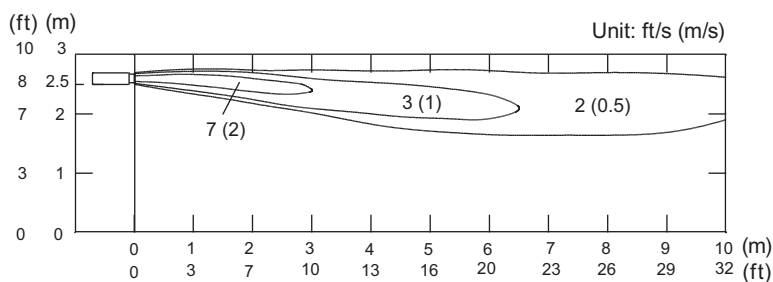

Measuring conditions	Fan speed	Operation mode
	HIGH	HEAT

• Air velocity distribution

Side view
Vertical airflow direction louver: Down
Horizontal airflow direction louver: Center

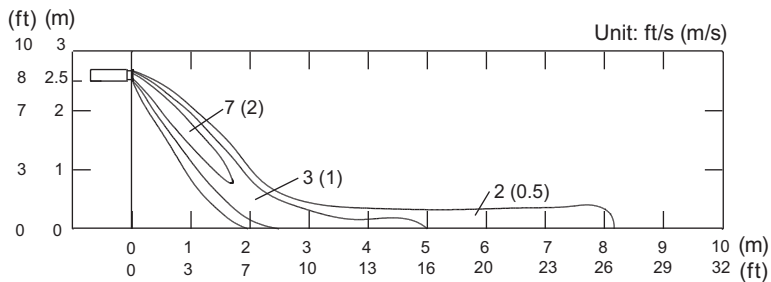

• Air temperature distribution

Side view
Vertical airflow direction louver: Down
Horizontal airflow direction louver: Center

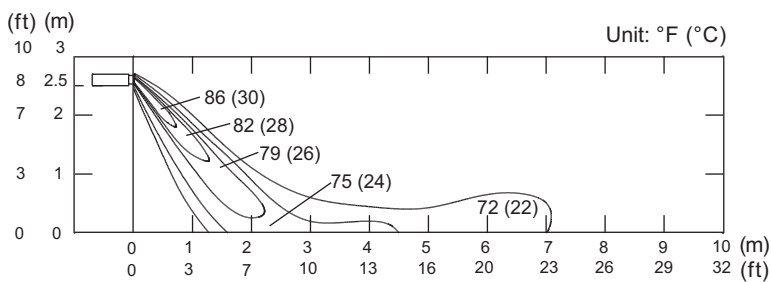

5-2. Fan performance curve

Model: ADUH09LUAS1

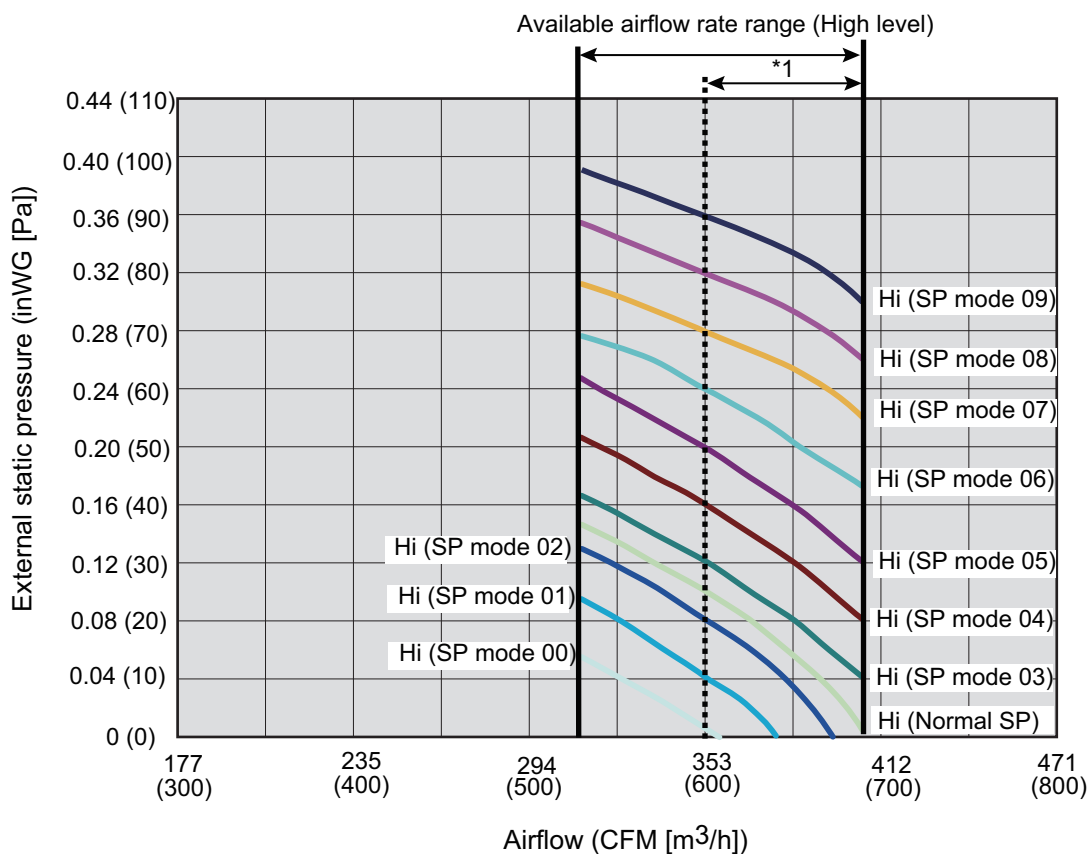
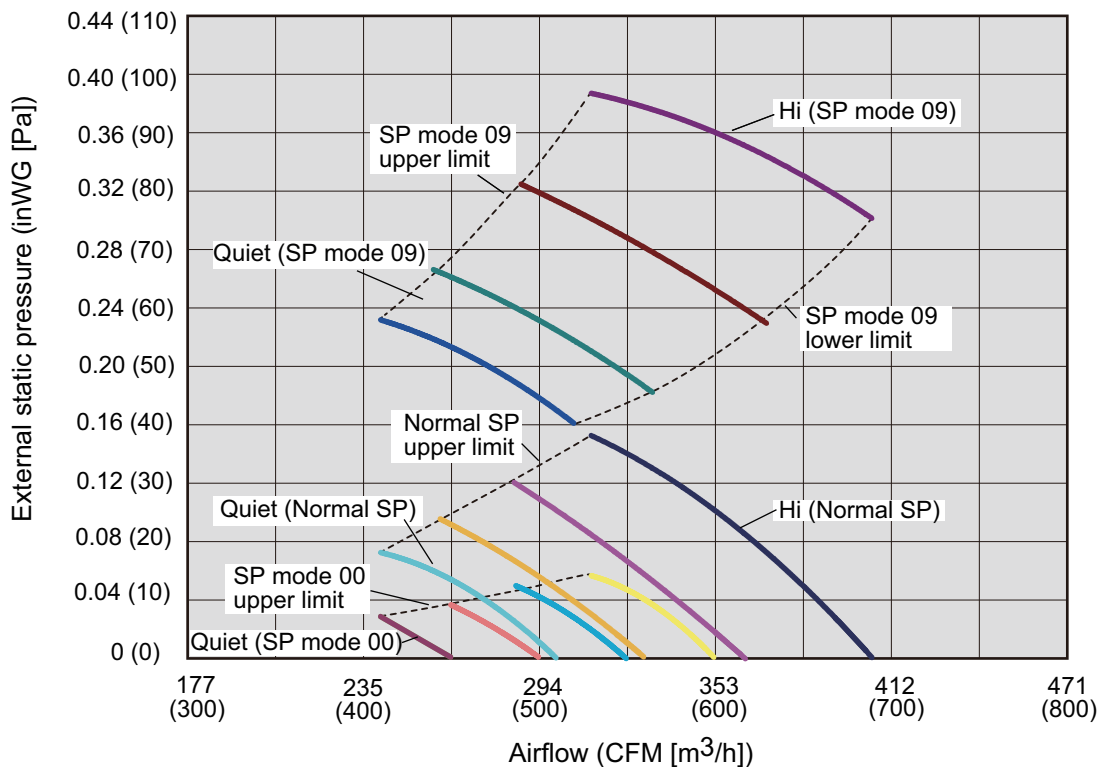

*1: Available airflow rate range when Auto louver grille (option) is installed.
 Fan speed : HIGH
 Vertical airflow direction louver : Up

● Characteristics of air volume and capacity

• Cooling

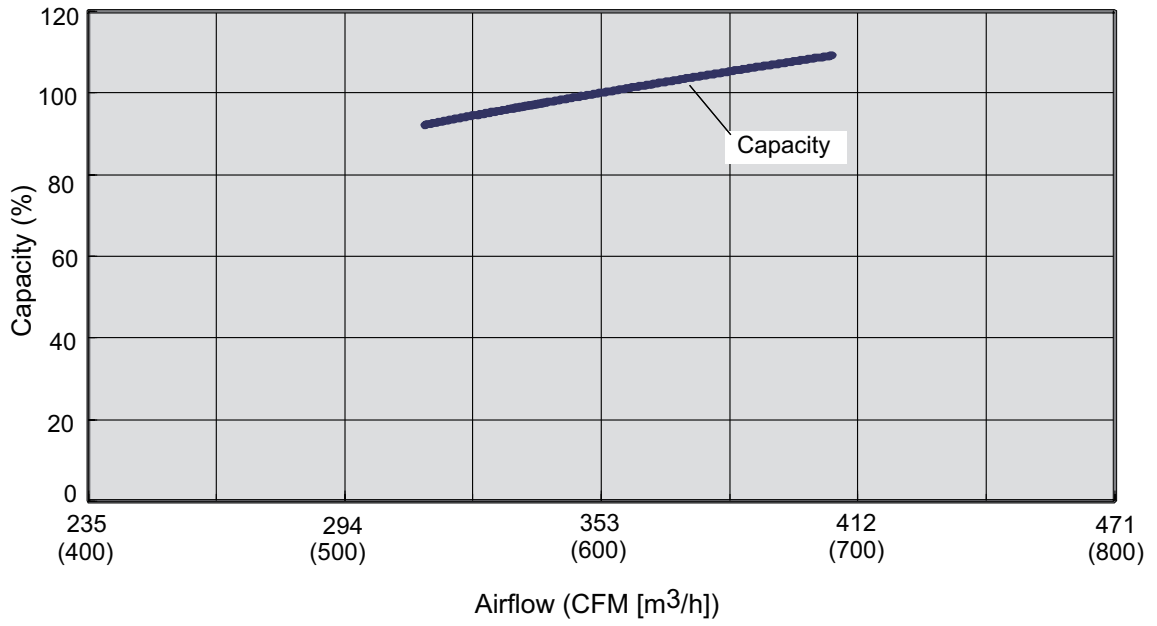

• Heating

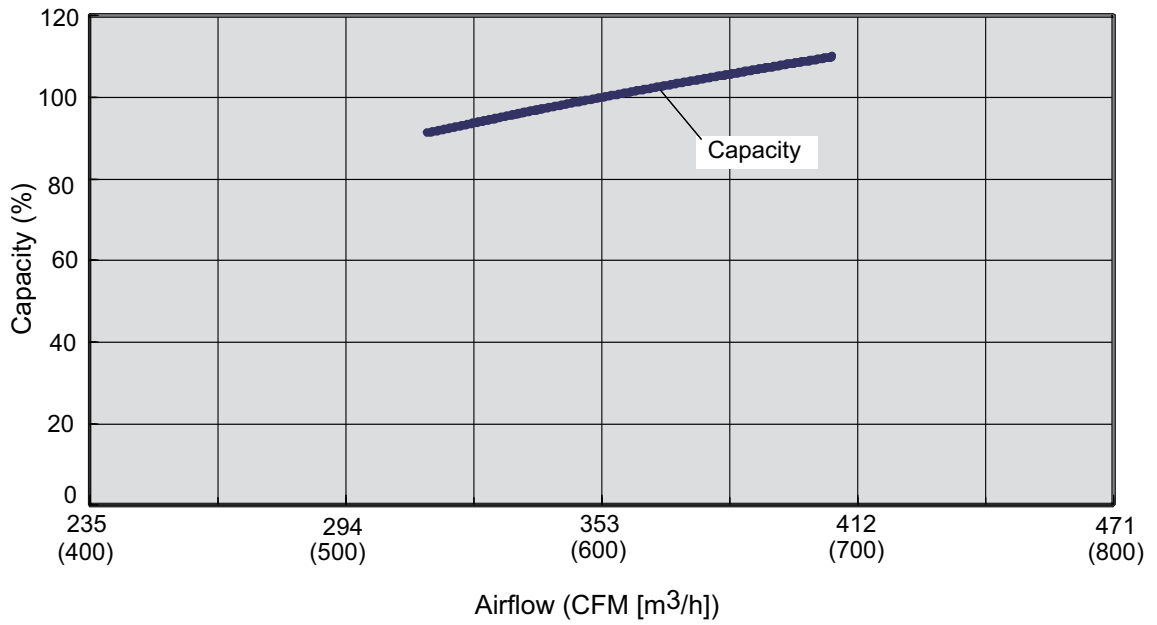

Model: ADUH12LUAS1

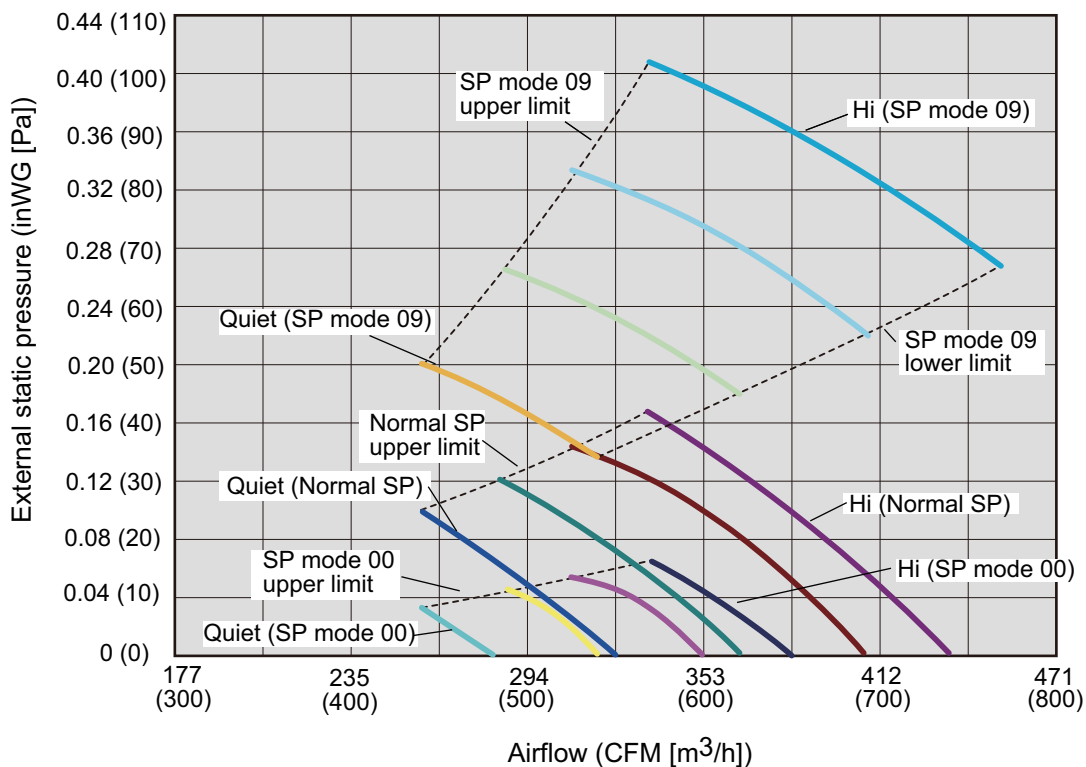

Available airflow rate range (High level)

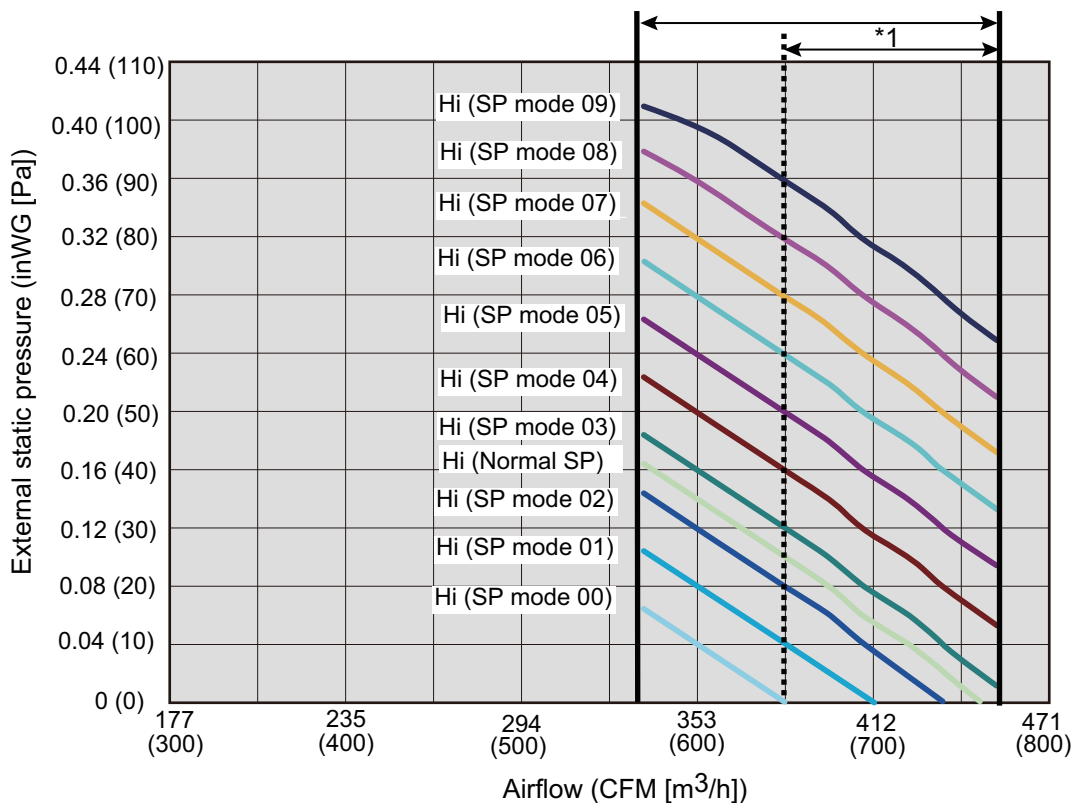

*1: Available airflow rate range when Auto louver grille (option) is installed.
 Fan speed : HIGH
 Vertical airflow direction louver : Up

● Characteristics of air volume and capacity

• Cooling

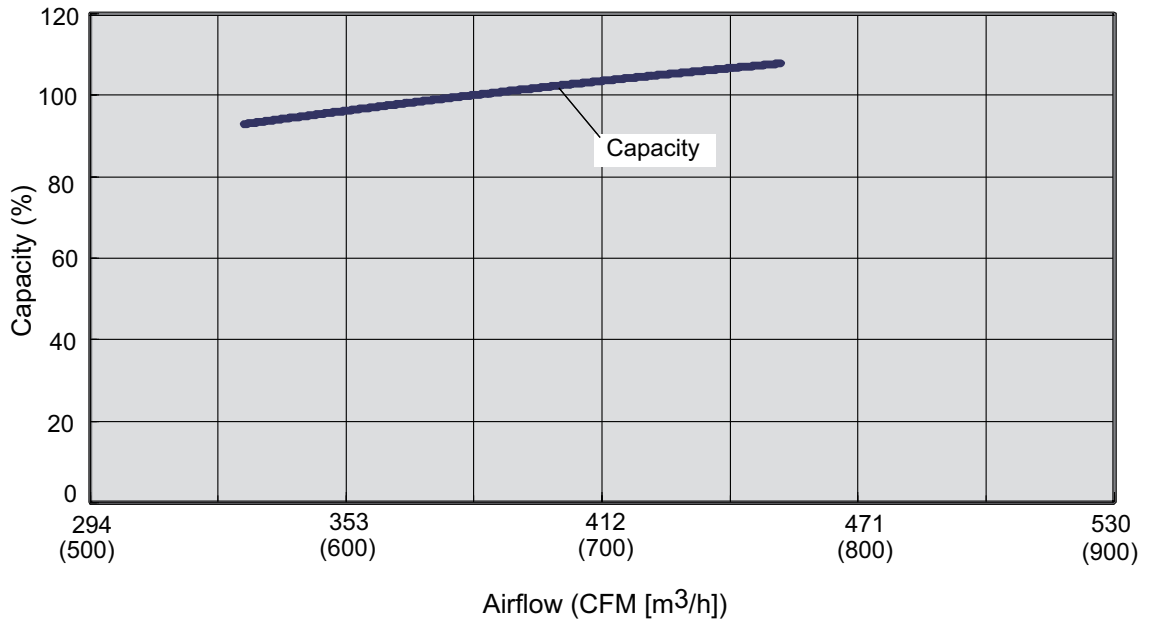

• Heating

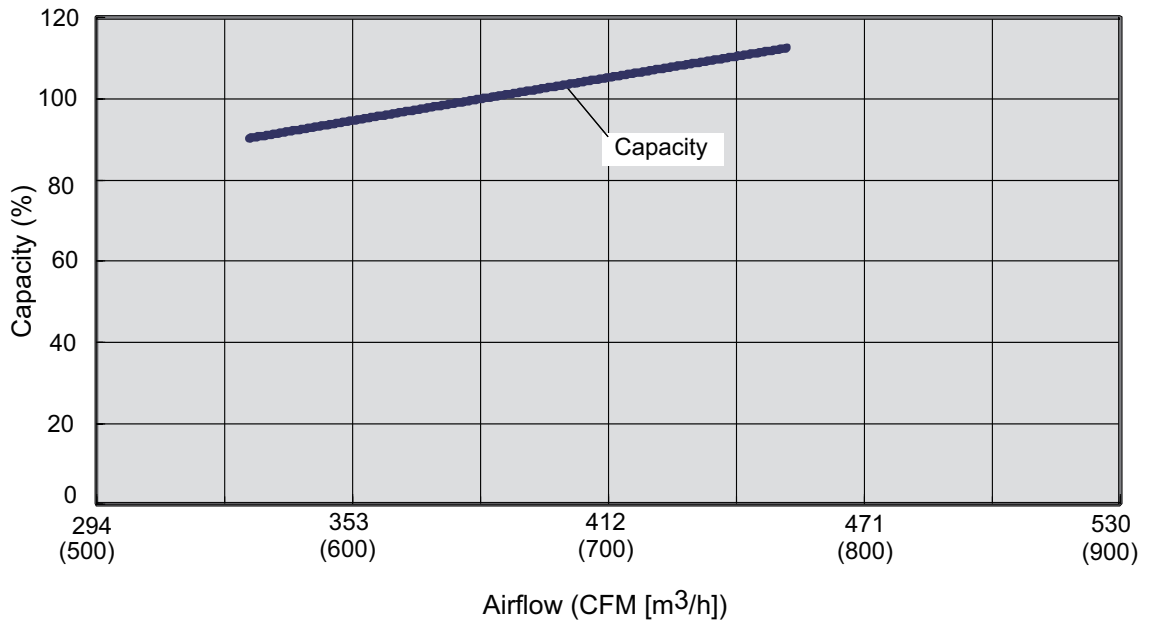

Model: ADUH18LUAS1

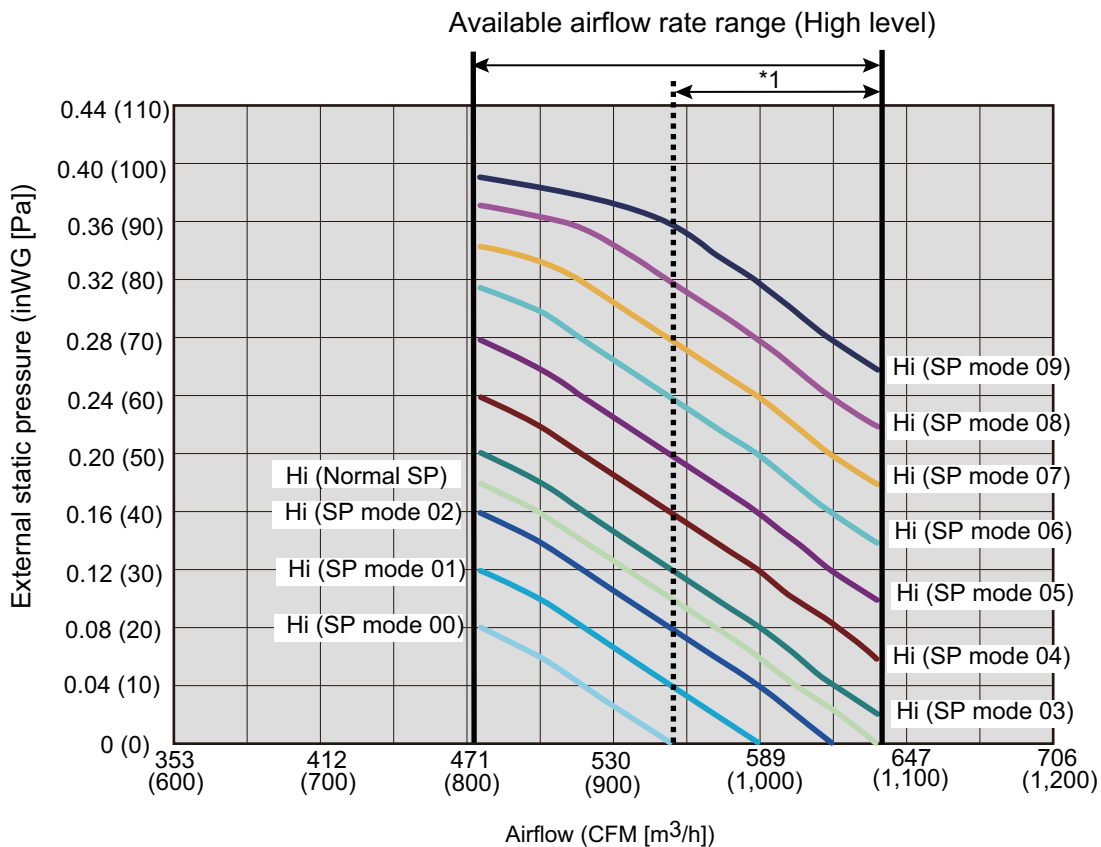
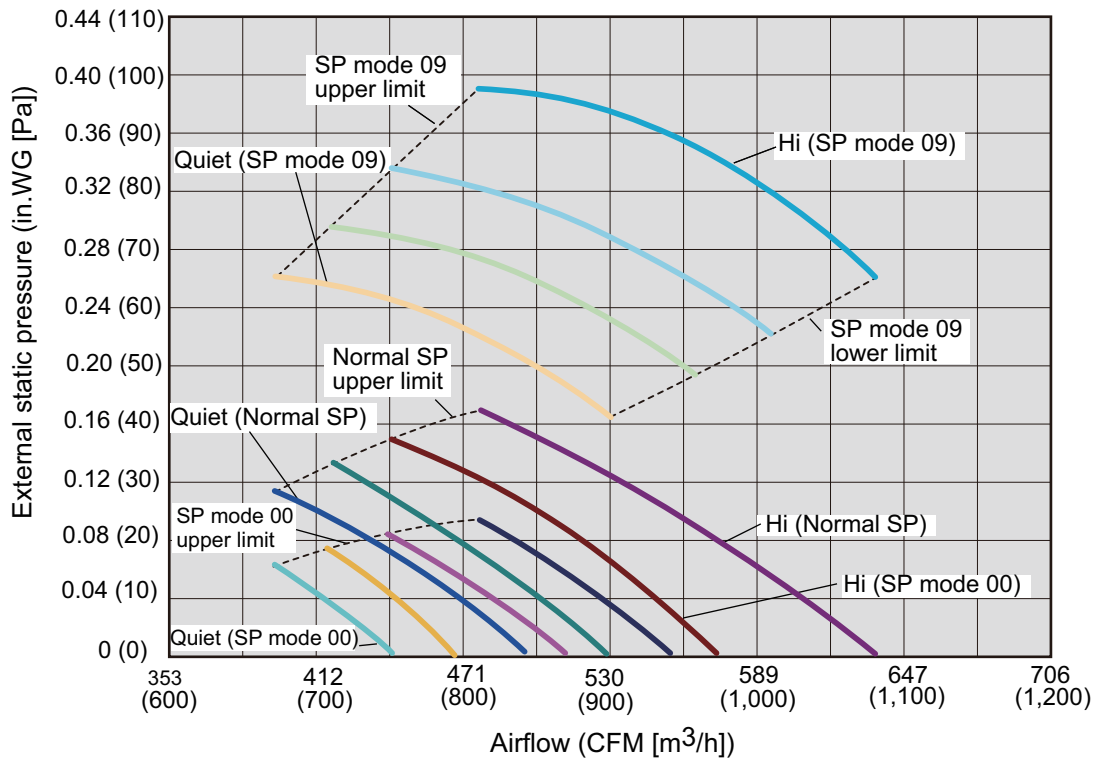

*1: Available airflow rate range when Auto louver grille (option) is installed.
 Fan speed : HIGH
 Vertical airflow direction louver : Up

● Characteristics of air volume and capacity

• Cooling

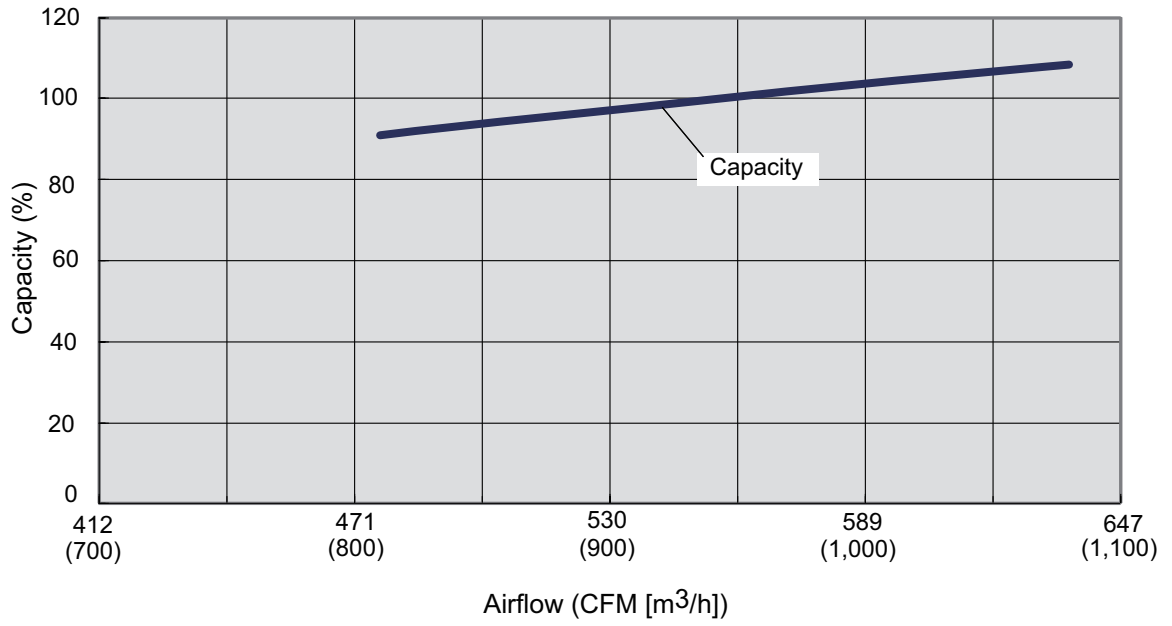

• Heating

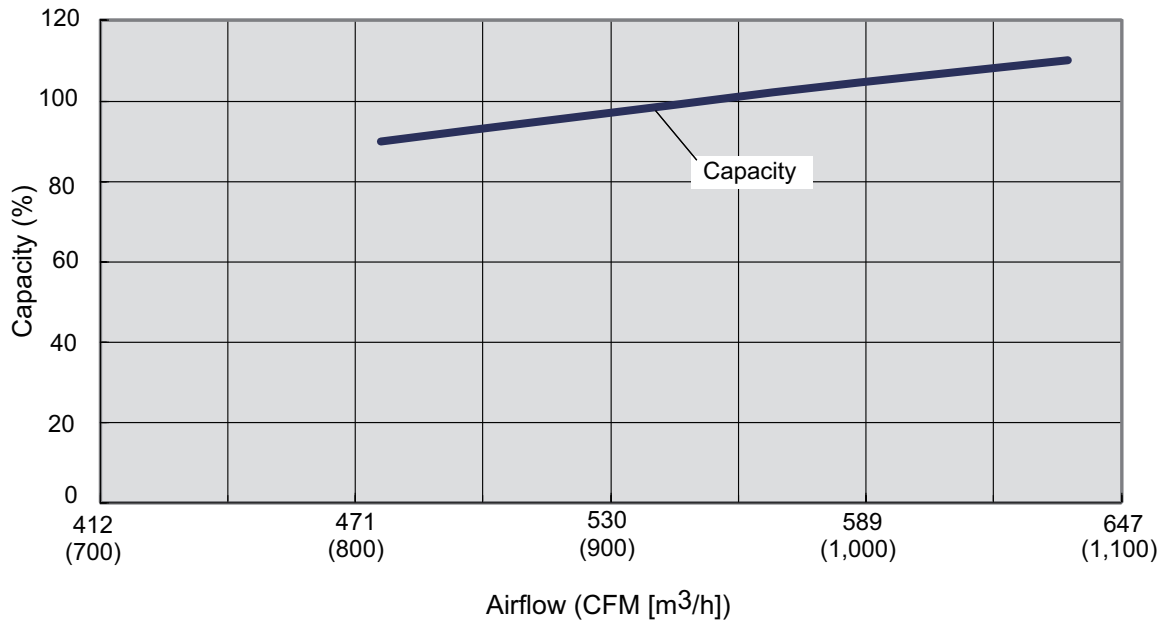

5-3. Airflow

Conversion factor:

- $1 \text{ m}^3/\text{h} = 0.2778 \text{ l/s} = 0.5886 \text{ CFM}$
- $3.6 \text{ m}^3/\text{h} = 1 \text{ l/s}$
- $1.699 \text{ m}^3/\text{h} = 1 \text{ CFM}$

■ Model: ADUH09LUAS1

● Cooling

Fan speed	Airflow	
HIGH	m^3/h	600
	l/s	167
	CFM	353
MED	m^3/h	550
	l/s	153
	CFM	324
LOW	m^3/h	500
	l/s	139
	CFM	294
QUIET	m^3/h	450
	l/s	125
	CFM	265

● Heating

Fan speed	Airflow	
HIGH	m^3/h	600
	l/s	167
	CFM	353
MED	m^3/h	550
	l/s	153
	CFM	324
LOW	m^3/h	500
	l/s	139
	CFM	294
QUIET	m^3/h	450
	l/s	125
	CFM	265

■ Model: ADUH12LUAS1

● Cooling

Fan speed	Airflow	
HIGH	m ³ /h	650
	l/s	181
	CFM	382
MED	m ³ /h	600
	l/s	167
	CFM	353
LOW	m ³ /h	550
	l/s	153
	CFM	324
QUIET	m ³ /h	480
	l/s	133
	CFM	283

● Heating

Fan speed	Airflow	
HIGH	m ³ /h	650
	l/s	181
	CFM	382
MED	m ³ /h	600
	l/s	167
	CFM	353
LOW	m ³ /h	550
	l/s	153
	CFM	324
QUIET	m ³ /h	480
	l/s	133
	CFM	283

■ ADUH18LUAS1

● Cooling

Fan speed	Airflow	
HIGH	m ³ /h	940
	l/s	261
	CFM	553
MED	m ³ /h	880
	l/s	244
	CFM	518
LOW	m ³ /h	820
	l/s	228
	CFM	482
QUIET	m ³ /h	750
	l/s	208
	CFM	441

● Heating

Fan speed	Airflow	
HIGH	m ³ /h	940
	l/s	261
	CFM	553
MED	m ³ /h	880
	l/s	244
	CFM	518
LOW	m ³ /h	820
	l/s	228
	CFM	482
QUIET	m ³ /h	750
	l/s	208
	CFM	441

6. Operation noise (sound pressure)

6-1. Noise level curve

Model: ADUH09LUAS1

● Cooling

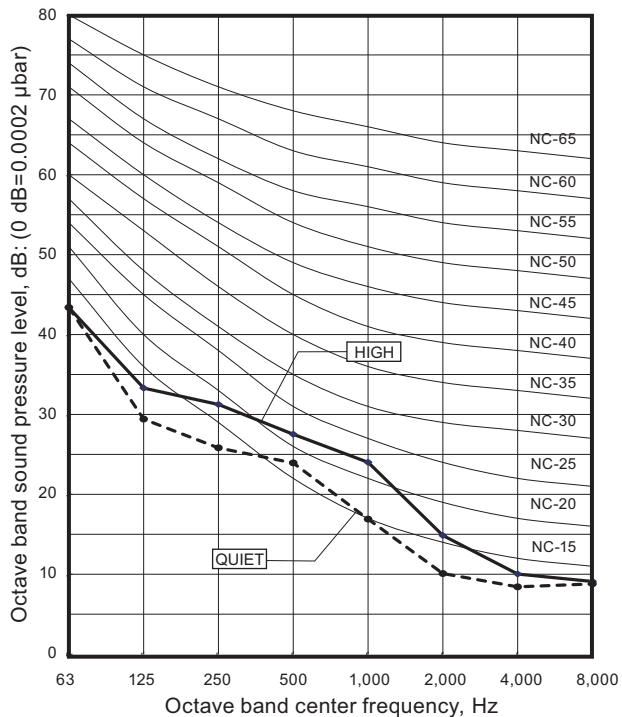

● Heating

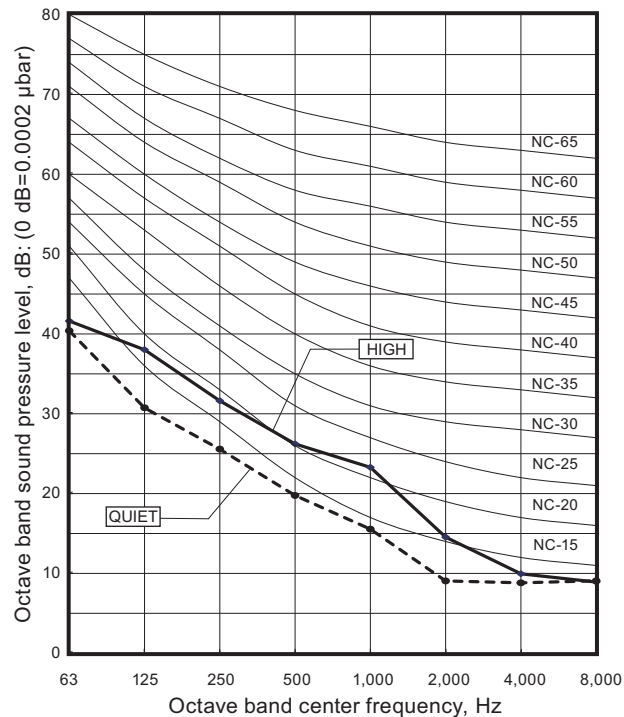

Model: ADUH12LUAS1

● Cooling

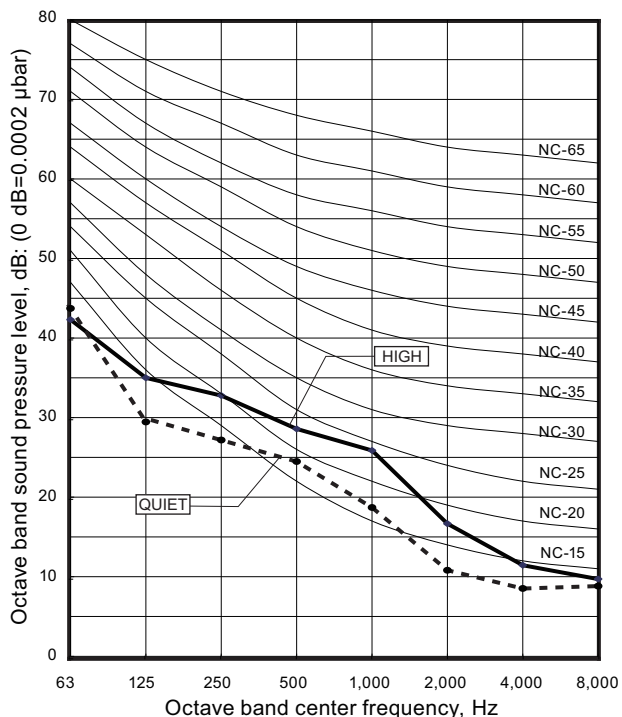

● Heating

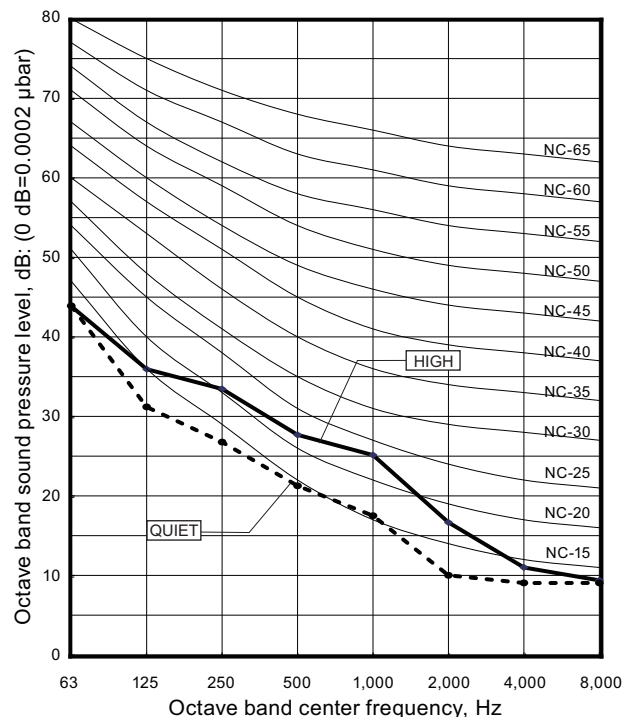

■ Model: ADUH18LUAS1

● Cooling

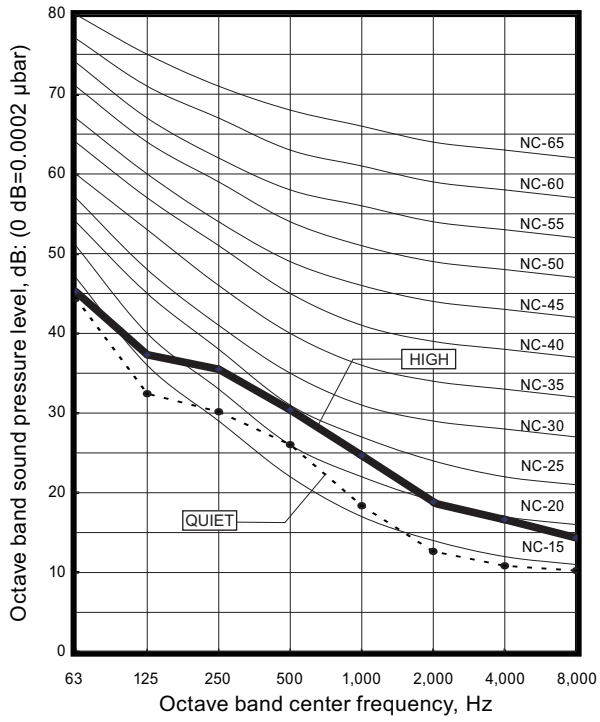

● Heating

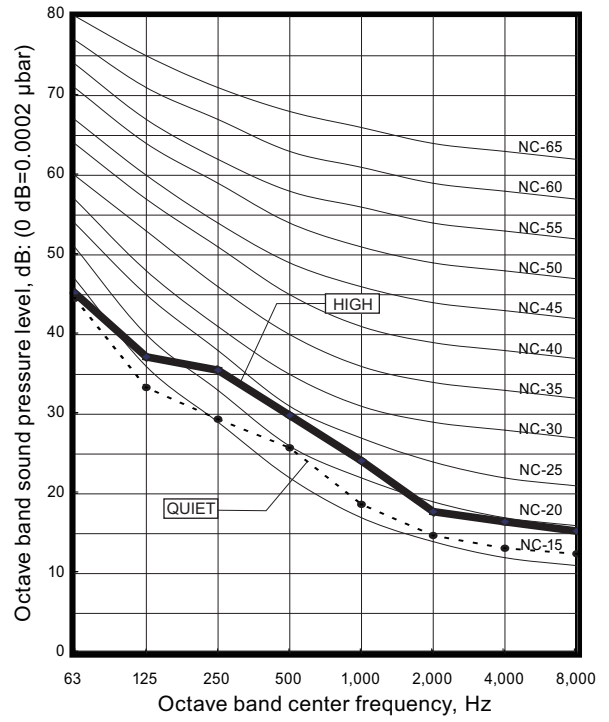

6-2. Sound level check point

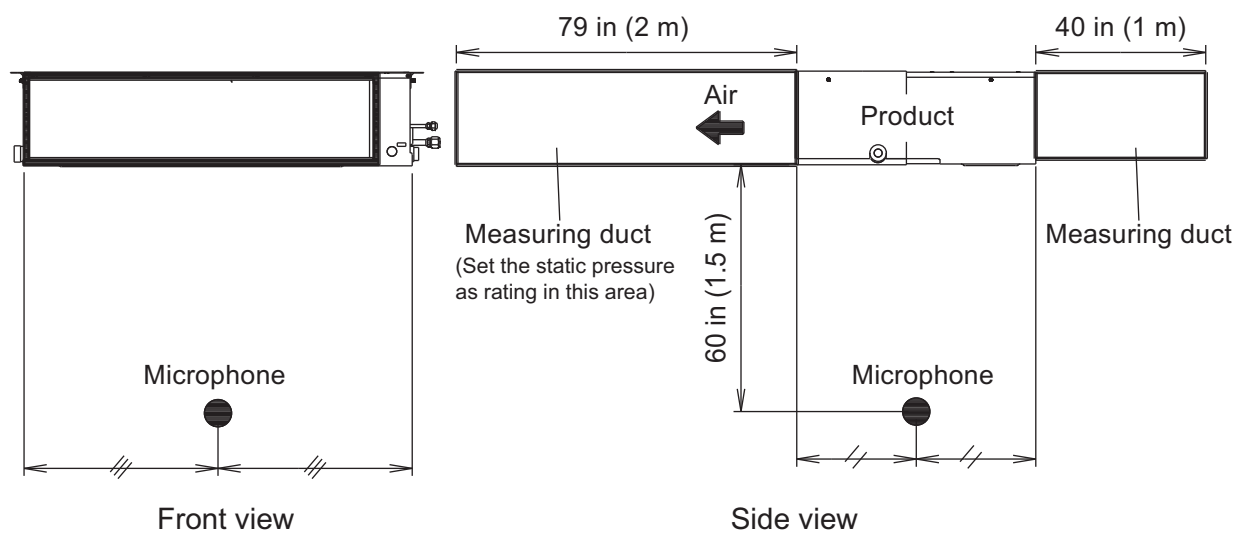

7. Safety devices

Type of protection	Protection form		Model
			ADUH09LUAS1 ADUH12LUAS1 ADUH18LUAS1
Circuit protection	Current fuse (PCB*)		250 V, 5 A
Fan motor protection	Thermal protection program	Activate	275±27 °F (135±15 °C) Fan motor stop
		Reset	239±27 °F (115±15 °C) Fan motor restart
	Current protection		1.31—1.71 A

*: Printed Circuit Board

8. External input and output

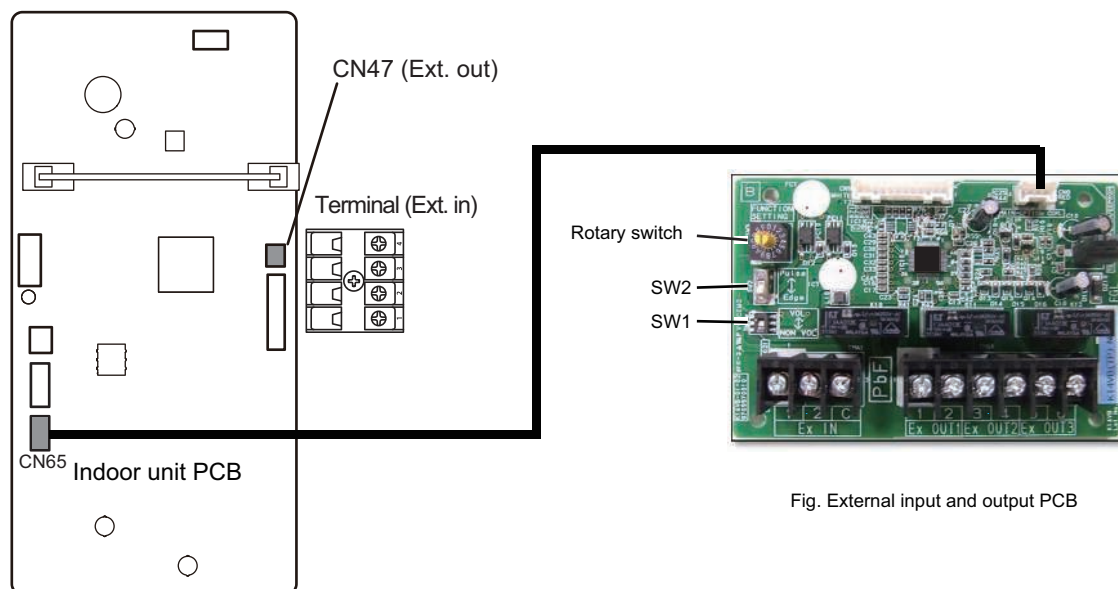

Fig. External input and output PCB

PCB	External input	External output	Connector	Input select	Input signal	External connect kit (Optional parts)
Indoor unit	Operation/Stop Forced stop	—	Terminal	Dry contact	Edge	—
	—	Operation status	CN47	—	—	UTY-XWZXZG
		Error status				
		Indoor unit fan operation status				
—	External heater output	CN47	—	—	—	
External input and output (UTY-XCSX)	Operation/Stop	—	Input 1/ Input 2	Dry contact/ Apply voltage	Edge/ Pulse	—
	Forced thermostat off		Input 1		Edge	
	—	Operation status	Output 1 Output 2 Output 3	—	—	—
		Error status				
Indoor unit fan operation status						
—	External heater output	—	—	—	—	

8-1. External input

- “Operation/Stop” mode or "Forced stop" mode can be selected with function setting of indoor unit.
- A twisted pair cable (22AWG) should be used. Maximum length of cable is 492 ft (150 m).
- The wire connection should be separate from the power cable line.

Indoor unit functions such as Operation/Stop can be done by using indoor unit terminals.

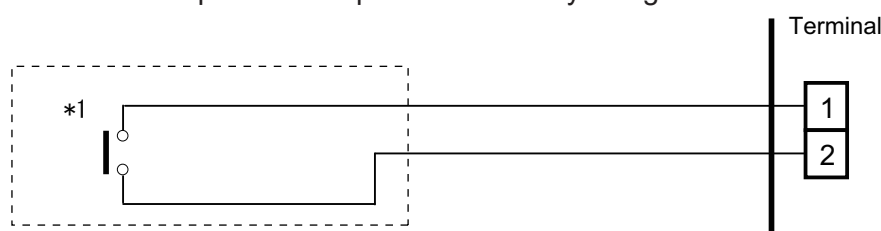

*1: The switch can be used on the following condition: DC 12 V to 24 V, 1 mA to 15 mA.

External input and output PCB

The indoor unit Operation/Stop can be set by using the input terminal on the PCB.

Input select

Use either one of these types of terminals according to the application. (Both types of terminals cannot be used simultaneously.)

- Dry contact

In case of internal power supply, set the slide switch of SW1 to "NON VOL" side.

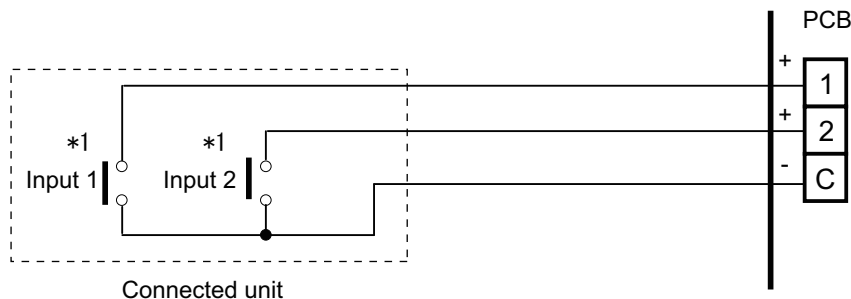

*1: The switches can be used on the following condition: DC 12 V to 24 V, 1 mA to 15 mA.

- Apply voltage

In case of external power supply, set the slide switch of SW1 to "VOL" side.

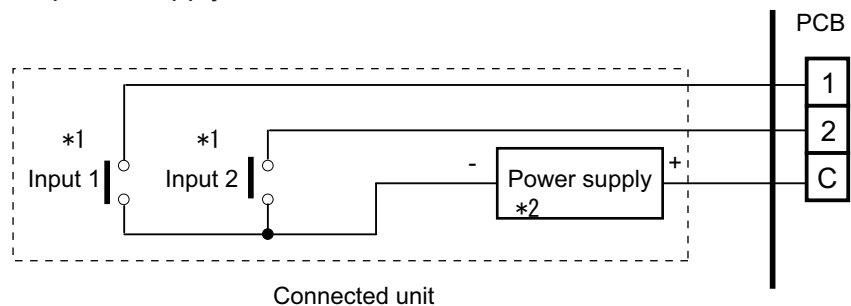

*1: The switches can be used on the following condition: DC 12 V to 24 V, 1 mA to 15 mA.

*2: Make the power supply DC 12 V to 24 V 10 mA or more.

8-2. External output

Use an external output cable with appropriate external dimension, depending on the number of cables to be installed.

- A twisted pair cable (22AWG) should be used. Maximum length of cable is 82 ft (25 m).
- Output voltage: High DC 12 V \pm 2 V, Low 0 V.
- Permissible current: 50 mA
- For details, refer to "[Combination of external input and output](#)" on page 36.

● When indicator, etc. are connected directly

Example: Function setting 60 is set to "00"

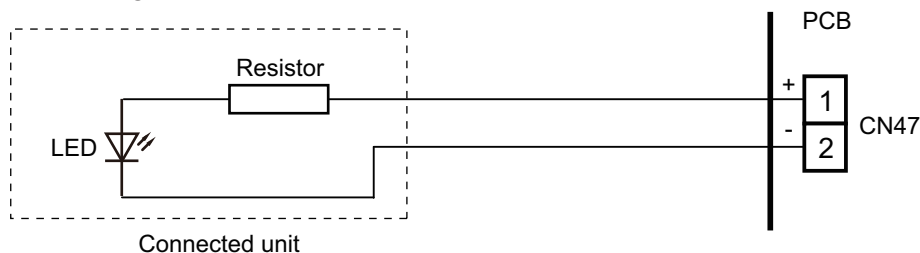

● When connecting with a device equipped with a power supply

Example: Function setting 60 is set to "00"

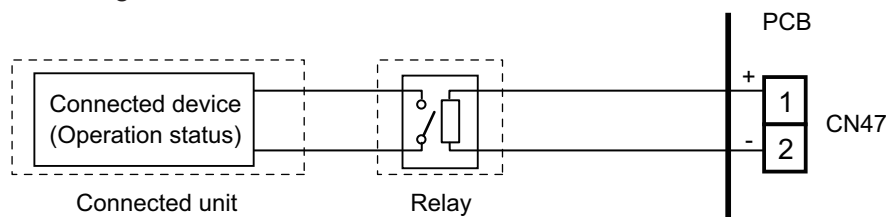

External input and output PCB

- A twisted pair cable (22AWG) should be used.
- Permissible voltage and current: DC 5 V to 30 V / 3 A, AC 30 V to 250 V / 3 A
- For details, refer to Chapter 8-3. "[Combination of external input and output](#)" on page 36.

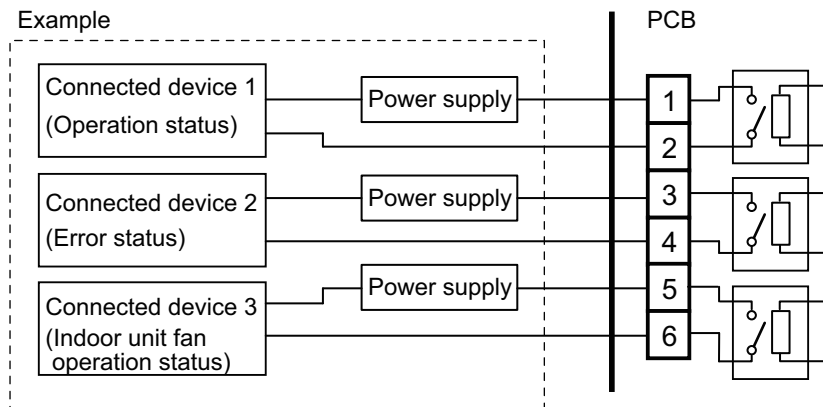

8-3. Combination of external input and output

By combining the function setting of the indoor unit and rotary switch setting of the External input and output PCB, you can select various combinations of functions.

Combination examples of external input and output are as follows:

Mode	Function setting	External input and output PCB (Rotary SW)	External input			
			Indoor unit Input	External input and output PCB		
			Terminal	Input 1	Input 2	Signal type
0-1	60-00	1	Operation/Stop (Function setting 46-00) or Forced stop (Function setting 46-02)	Operation/Stop	Not available	Edge
				Operation	Stop	Pulse
0-2	60-00	2		Forced Thermostat OFF	Not available	Edge
1	60-01	3		Mechanical cooling Off		
2	60-02	4		Forced thermostat Off		
3	60-03	5		Mechanical cooling On		
4	60-04	6		Mechanical cooling On		
5	60-05	7		Forced thermostat Off		
6	60-06	8		Forced thermostat Off		
7	60-07	9		Mechanical cooling Off		
8	60-08	A		Forced thermostat Off		
9	60-09	B		Forced Thermostat OFF		
10	60-10	C	Forced Thermostat OFF			
11	60-11	D	Forced Thermostat OFF			
12	60-12	D	Forced Thermostat OFF			

Mode	Function setting	External input and output PCB (Rotary SW)	External output			
			Indoor unit Output	External input and output PCB		
			CN47	Output 1	Output 2	Output 3
0-1	60-00	1	Operation/Stop	Operation/Stop	Error status	Indoor unit fan operation status
0-2	60-00	2	Operation/Stop	Error status	Indoor unit fan operation status	External heater output
1	60-01	3	Cooling thermostat On	Error status	Indoor unit fan operation status	External heater output
2	60-02	4	Cooling thermostat On	Error status	Remote controller output	External heater output
3	60-03	5	Cooling thermostat On	Cooling high/low output	Remote controller output	External heater output
4	60-04	6	Cooling thermostat On	Error status	Remote controller output	Cooling high/low output
5	60-05	7	Heating thermostat On	Error status	Indoor unit fan operation status	External heater output
6	60-06	8	Operation/Stop	Error status	Indoor unit fan operation status	Heating thermostat On
7	60-07	9	Cooling thermostat On	Error status	Heating thermostat On	External heater output
8	60-08	A	Cooling thermostat On	Heating thermostat On	Remote controller output	External heater output
9	60-09	B	Error status	Operation/Stop	Indoor unit fan operation status	External heater output
10	60-10	C	Indoor unit fan operation status	Operation/Stop	Error status	External heater output
11	60-11	D	External heater output	Operation/Stop	Indoor unit fan operation status	Error status
12	60-12	D	Set point attainment status	Operation/Stop	Indoor unit fan operation status	Error status

NOTE: Input of Operation/Stop depends on the setting of function setting 46.

00: Operation/Stop mode 1 (R.C. enabled)

01: (Setting prohibited)

02: Forced stop

03: Operation/Stop mode 2 (R.C. disabled)

■ Input signal type

- Indoor unit
Input signal type is only "Edge".

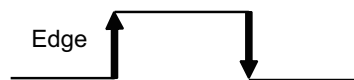

- External input and output PCB
The input signal type can be selected.

Signal type (edge or pulse) can be switched by the DIP switch 2 (SW2) on the External input and output PCB.

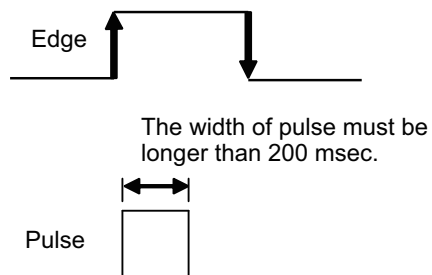

8-4. Details of function

■ Control input function

● When function setting is "Operation/Stop" mode 1

- In the case of "Edge" input

Function setting /	Rotary SW of External input and output PCB	External input		Input signal	Command
46-00	-	Input of indoor unit	Terminal	Off → On	Operation
				On → Off	Stop
	60-00 / 1	External input and output PCB	Input 1	Off → On	Operation
				On → Off	Stop

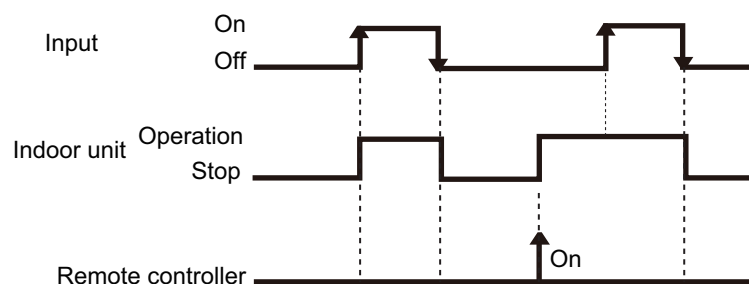

- In the case of "Pulse" input

Function setting /	Rotary SW of External input and output PCB	External input		Input signal	Command
46-00	60-00 / 1	External input and output PCB	Input 1	Pulse	Operation
			Input 2	Pulse	Stop

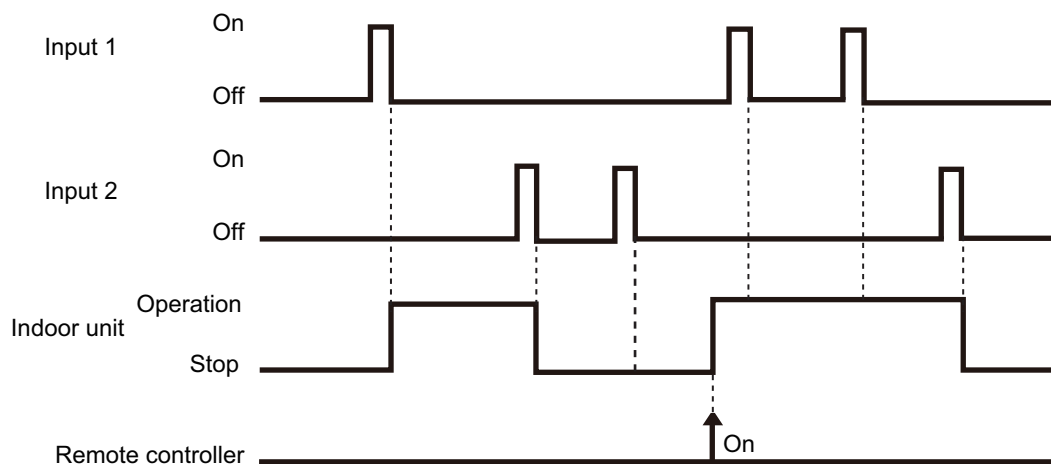

NOTES:

- The last command has priority.
- The indoor units within the same remote controller group operates in the same mode.

● When function setting is "Forced stop" mode

- In the case of "Edge" input

Function setting /	Rotary SW of External input and output PCB	External input		Input signal	Command
46-02	-	Input of indoor unit	Terminal	Off → On	Forced stop
				On → Off	Normal
	60-00 / 1	External input and output PCB	Input 1	Off → On	Forced stop
				On → Off	Normal

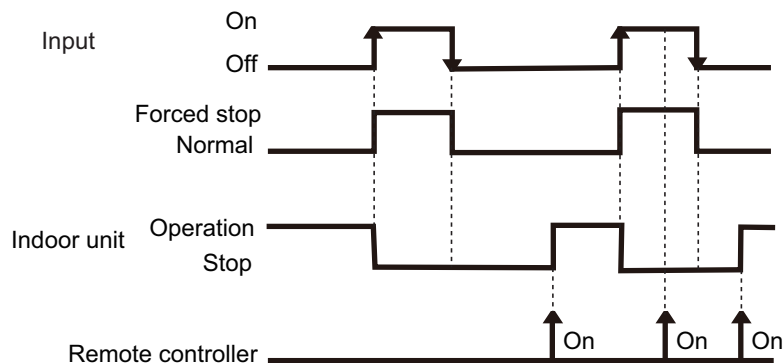

- In the case of "Pulse" input

Function setting /	Rotary SW of External input and output PCB	External input		Input signal	Command
46-02	60-00 / 1	External input and output PCB	Input 1	Pulse	Forced stop
			Input 2	Pulse	Normal

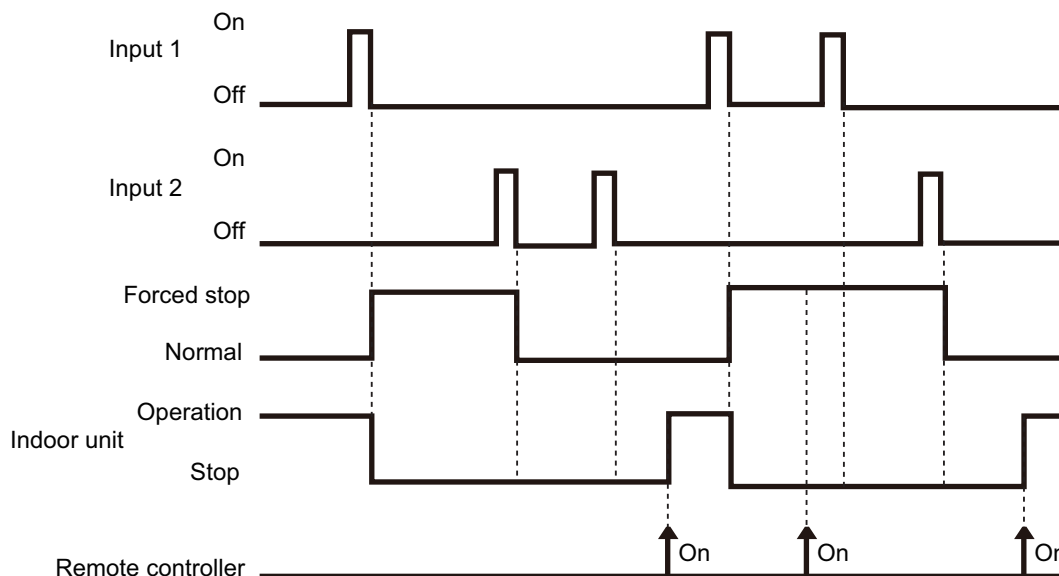

NOTES:

- When the forced stop is triggered, indoor unit stops and Operation/Stop operation by the remote controller is restricted.
- When forced stop function is used with forming a remote controller group, connect the same equipment to each indoor unit within the group.

● When function setting is "Operation/Stop" mode 2

- In the case of "Edge" input

Function setting /	Rotary SW of External input and output PCB	External input		Input signal	Command
46-03	-	Input of indoor unit	Terminal	Off → On	Operation
				On → Off	Stop (R.C. disabled)
	60-00 / 1	External input and output PCB	Input 1	Off → On	Operation
				On → Off	Stop (R.C. disabled)

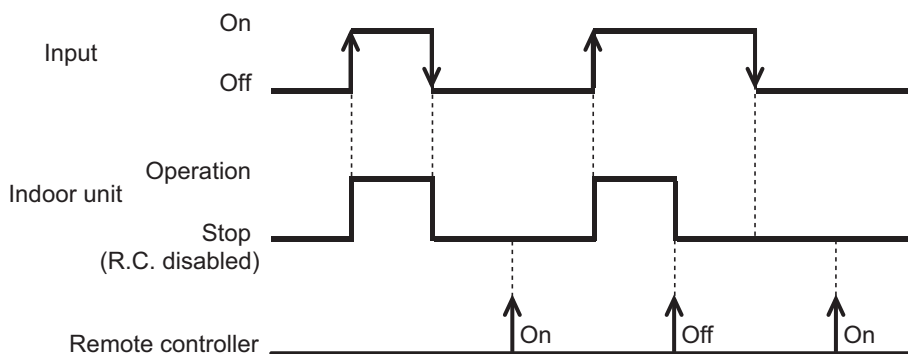

- In the case of "Pulse" input

Function setting /	Rotary SW of External input and output PCB	External input		Input signal	Command
46-03	60-00 / 1	External input and output PCB	Input 1	Pulse	Operation
			Input 2	Pulse	Stop (R.C. disabled)

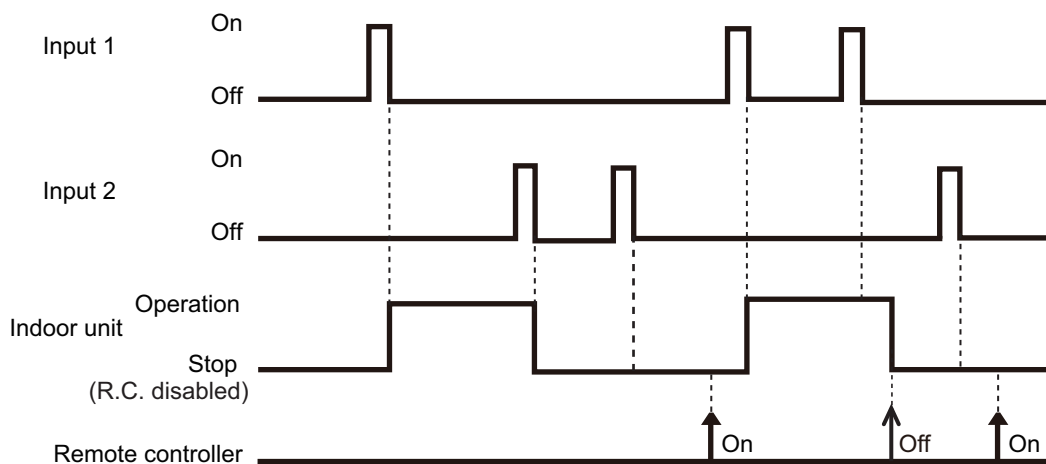

NOTES:

- When "Operation/Stop" mode 2 function is used with forming a remote controller group, connect the same equipment to each indoor unit within the group.

■ Forced thermostat off function

Function setting /	Rotary SW of External input and output PCB	External input		Input signal	Command
60-00 / 2 60-02 / 4 60-05 / 7 60-06 / 8 60-08 / A 60-09 / B 60-10 / C 60-11 / D		External input and output PCB	Input 1	Off → On	Thermostat off
				On → Off	Normal operation

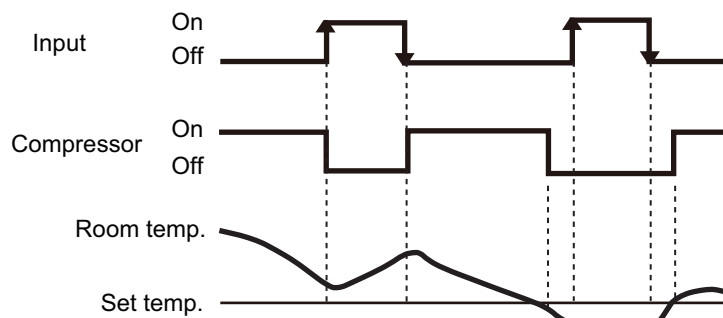

■ Control output function

Function setting /	Rotary SW of External input and output PCB	External output		Output signal	Command
60-00 / 1, 2 60-06 / 8		Output of indoor unit	CN47	Low → High	Operation
				High → Low	Stop
60-00 / 1 60-09 / B 60-10 / C 60-11 / D		External input and output PCB	Output 1	Off → On	Operation
				On → Off	Stop

The output is low when the unit is stopped.

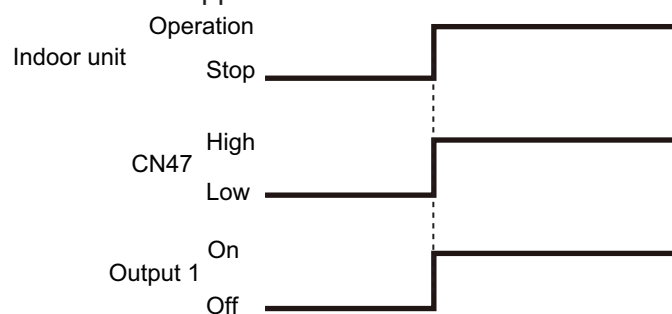

■ Error status

Function setting /	Rotary SW of External input and output PCB	External output		Output signal	Command
60-09 / B		Output of indoor unit	CN47	Low → High	Error
				High → Low	Normal
60-00 / 2 60-01 / 3 60-02 / 4 60-04 / 6 60-05 / 7 60-06 / 8 60-07 / 9		External input and output PCB	Output 1	Off → On	Error
				On → Off	Normal
				Off → On	Error
				On → Off	Normal
				Off → On	Error
				On → Off	Normal
60-00 / 1 60-10 / C			Output 2	Off → On	Error
				On → Off	Normal
60-11 / D			Output 3	Off → On	Error
				On → Off	Normal

The output is ON when an error is generated for the indoor unit.

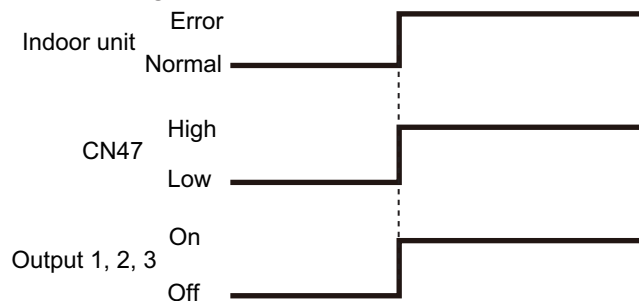

Indoor unit fan operation status

Function setting / Rotary SW of External input and output PCB	External output		Output signal	Command
60-10 / C	Output of indoor unit	CN47	Low → High	Fan run
			High → Low	Fan stop
60-00 / 2 60-01 / 3 60-05 / 7 60-06 / 8 60-09 / B 60-11 / D	External input and output PCB	Output 2	Off → On	Fan run
			On → Off	Fan stop
		Output 3	Off → On	Fan run
			On → Off	Fan stop
60-00 / 1				

Output signal	Condition
On Low → High	The indoor unit fan is operating.
Off High → Low	The fan is stopped or during cold air prevention. During thermostat off when in dry mode operation.

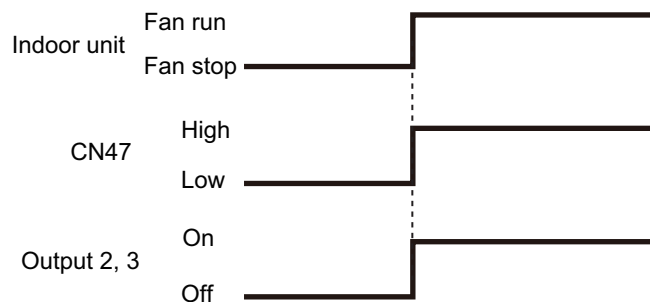

External heater output

Control	Primary heater	Auxiliary heater	Function setting
			Indoor unit
			Control switching external heaters No. 61
Auxiliary heater control 1	Heat pump	External device* ¹	61-00
Auxiliary heater control 2	Heat pump	External device	61-01
Heat pump prohibition control	External device	None	61-02
Auxiliary heater control by outdoor temperature 1	Heat pump	External device	61-03
Auxiliary heater control by outdoor temperature 2	Heat Pump	External device	61-04
Auxiliary heater control by outdoor temperature 3	Heat Pump	External device	61-05
Auxiliary heat pump control	External device	Heat pump	61-06
Auxiliary heat pump control by outdoor temperature 1	External device	Heat pump	61-07
Auxiliary heat pump control by outdoor temperature 2	External device	Heat pump	61-08
Auxiliary heat pump control by outdoor temperature 3	External device	Heat pump	61-09

NOTES:

- After turning off the heater, 3 minutes of standby time is required by next power-on of the heater.
- For items marked “—” in the table, any of validate or invalidate of the setting are acceptable.
- *1: External device means Hot water, Electrical heater, etc.

● Installation configuration of individual connection

External heating device is installed individually. (No use of indoor unit fan)

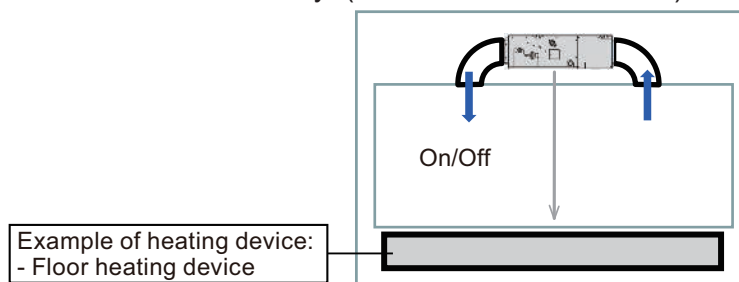

⚠ WARNING

- **DIP Switch 101-3 must be in the ON position when ducted electric heat application is being used.** DIP switch 101-3 is set in the ON position by default from the factory. When DIP switch 101-3 is in the ON position and ducted electric heat application is not being used, cold draft occurs due to fan delay off operation.

Operation			Condition
Heater off	DIP-SW101-3	On	<ul style="list-style-type: none"> • Heater is off as shown in following diagram of heating temperature. • Other than heating mode • Error occurred • Forced thermostat off • Fan stop protection
	Indoor unit fan setting for external heater	Enabled	
Heater off	DIP-SW101-3	Off	<ul style="list-style-type: none"> • Heater is off as shown in following diagram of heating temperature. • Other than heating mode • Error occurred • Forced thermostat off
	Indoor unit fan setting for external heater	Disabled	

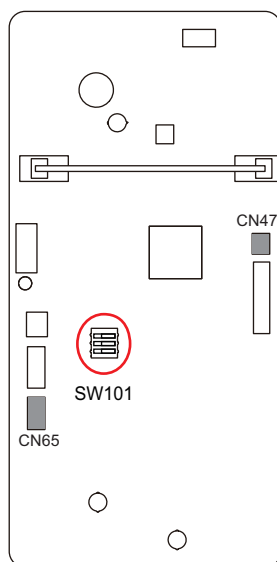

- Design and install external heater appropriately with considering its protection.

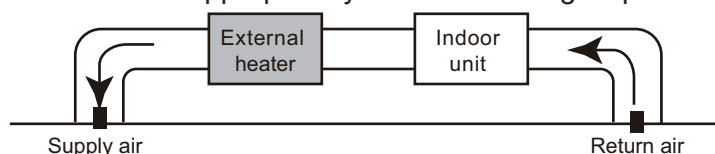

- Inappropriate designing and installation of external heater may cause a fire by emitted heat from the external heater.
- Fujitsu General Ltd. is not responsible for inappropriate designing or installation of external heating device.

● Auxiliary equipment control by room temperature

Auxiliary equipment control is switchable by room temperature. Auxiliary equipment switching is performed for each room temperature divided to following 3 zones.

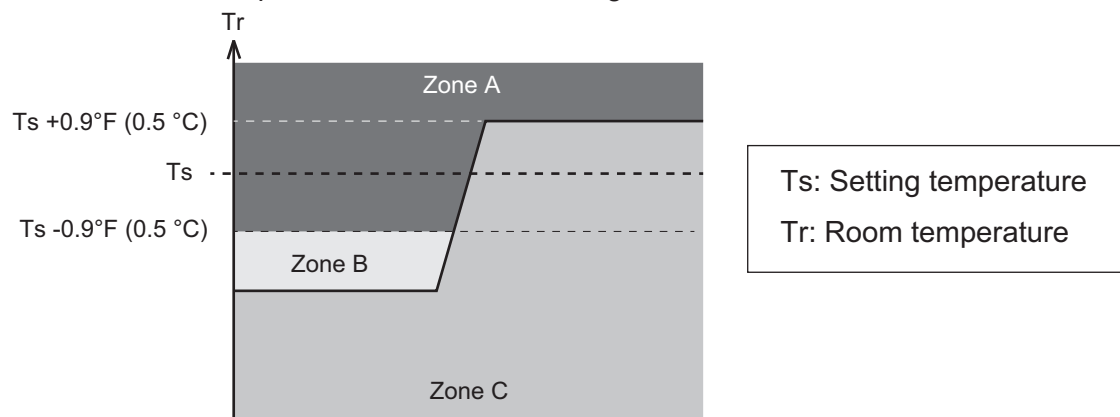

Zone	Application	When temperature dropping		When temperature rising	
		Primary	Auxiliary	Primary	Auxiliary
A	Both of primary and auxiliary equipment is unnecessary.	Off	Off	Off	Off
B	Primary heater only. When room temperature stays in zone B for a long time, auxiliary equipment also operates.	On	Off*1	—	—
C	Auxiliary equipment also operates.	On	On*2	On	On*2

*1: For standby time for auxiliary equipment operation, refer to indoor unit function number 71 "[Contents of function setting](#)" on page 66.

*2: When indoor unit function number 61 is set to "00", auxiliary equipment operates according to the following conditions.

- $T_s - T_r > 21.6 \text{ }^\circ\text{F}$ ($-12.0 \text{ }^\circ\text{C}$): Auxiliary equipment turn off.
- $T_s - T_r > 18.0 \text{ }^\circ\text{F}$ ($-10.0 \text{ }^\circ\text{C}$): Auxiliary equipment turn on.

● Auxiliary heater control 1

Operation	Condition
Heater on	Heater is on as shown in following diagram of heating temperature.
Heater off	<ul style="list-style-type: none"> • Heater is off as shown in following diagram of heating temperature. • Other than heating mode • Error occurred • Forced thermostat off • Fan stop protection

- Temperature of heater on (Thon): Adjustable by function number 62 (Operating temperature switching of external heaters).
- All control temperatures will shift by adjusting “Thon”.

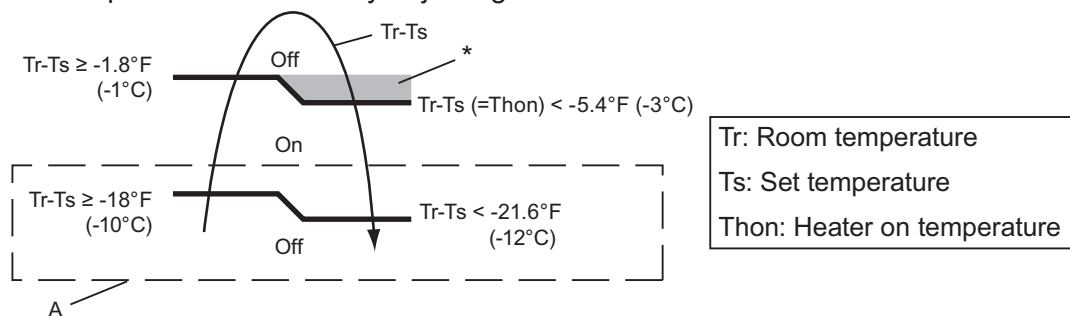

*: When room temperature stays in this zone for a specific time, auxiliary heater is turned on. For details, refer to function number 71.

Example: When set temperature (Ts) is 72°F (22°C) (Factory setting),

- and room temperature (Tr) increases above 53.6°F (12°C), signal output is on.
- and room temperature (Tr) increases above 69.8°F (21°C), signal output is off.
- and room temperature (Tr) decreases below 66.2°F (19°C), signal output is on.
- and room temperature (Tr) decreases below 50°F (10°C), signal output is off.

● Auxiliary heater control 2

Control that excludes “A” from "Auxiliary heater control 1" on page 48.

Operation	Condition
Heater on	Heater is on as shown in following diagram of heating temperature.
Heater off	<ul style="list-style-type: none"> • Heater is off as shown in following diagram of heating temperature. • Other than heating mode • Error occurred • Forced thermostat off • Fan stop protection

- Temperature of heater on (Thon): Adjustable by function number 62 (Operating temperature switching of external heaters).
- All control temperatures will shift by adjusting “Thon”.

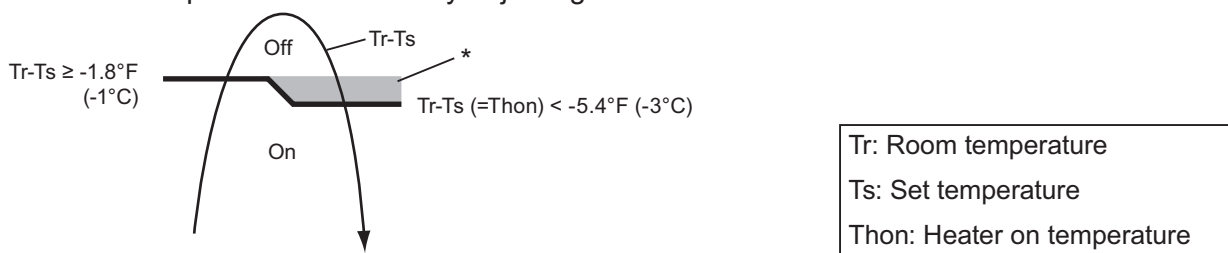

*: When room temperature stays in this zone for a specific time, auxiliary heater is turned on. For details, refer to function number 71.

● Heat pump prohibition control

Perform heating by external heater only. Indoor unit is continuous thermostat off.

Operation			Condition
Heater on			Heater is on as shown in following diagram of heating temperature.
Heater off	DIP-SW101-3 On Indoor unit fan setting for external heater Enabled	On	<ul style="list-style-type: none"> Heater is off as shown in following diagram of heating temperature. Other than heating mode Error occurred Forced thermostat off Fan stop protection
	DIP-SW101-3 Off Indoor unit fan setting for external heater Disabled	Off	<ul style="list-style-type: none"> Heater is off as shown in following diagram of heating temperature. Other than heating mode Error occurred Forced thermostat off

- Temperature of heater on (Thon): Adjustable by function number 62 (Operating temperature switching of external heaters).
- All control temperatures will shift by adjusting “Thon”.

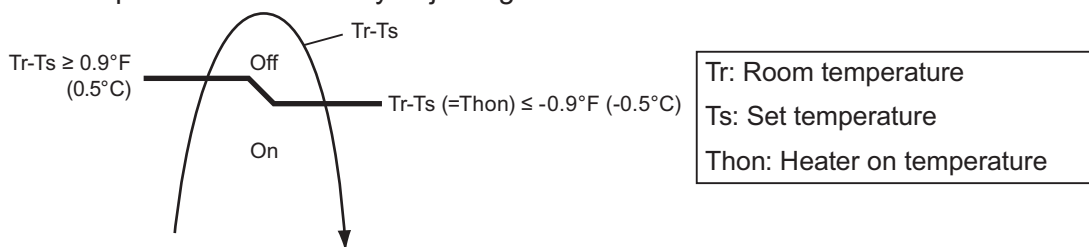

• Operation status

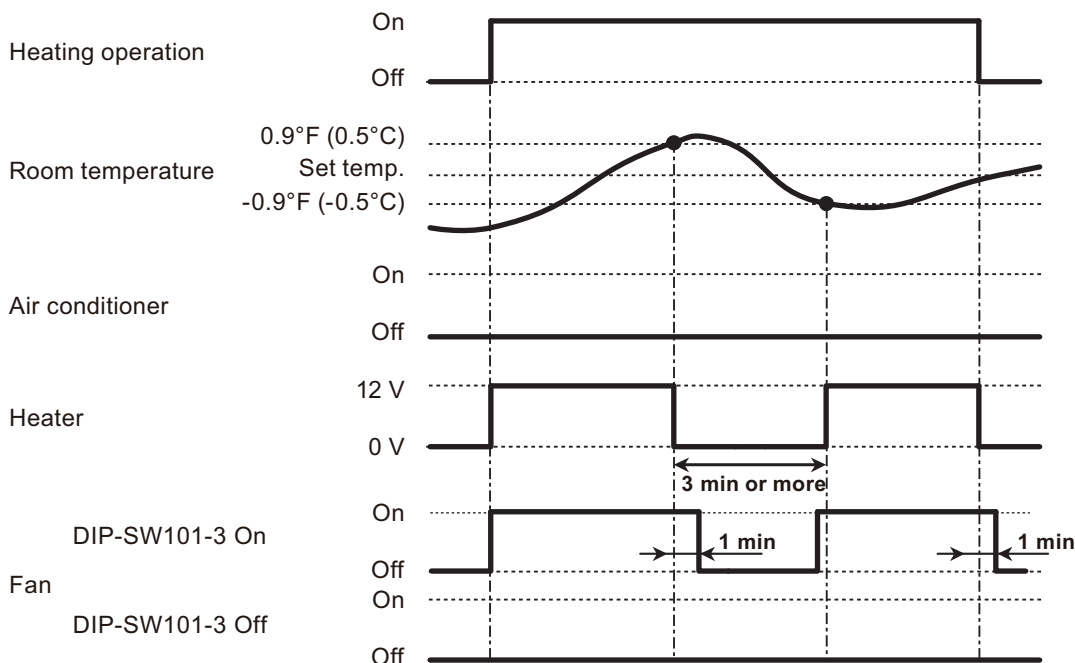

NOTE: In following operations, compressor will be on.

- Other than heating
- Test run

● Auxiliary heater control by outdoor temperature 1

This control selects heat pump or external heater according to the outdoor temperature. When outdoor temperature is high, the heating is performed by using heat pump only.

Operation		Condition
Heater on		Heater is on as shown in following diagram of heating temperature.
Heater off	DIP-SW101-3 On Indoor unit fan setting for external heater Enabled	<ul style="list-style-type: none"> Heater is off as shown in following diagram of heating temperature. Other than heating mode Error occurred Forced thermostat off Heat pump only zone Fan stop protection
	DIP-SW101-3 Off Indoor unit fan setting for external heater Disabled	<ul style="list-style-type: none"> Heater is off as shown in following diagram of heating temperature. Other than heating mode Error occurred Forced thermostat off Heat pump only zone

- Temperature of heater on (Thon): Adjustable by function number 62 (Operating temperature switching of external heaters).
- All control temperatures will shift by adjusting “Thon”.
- Outdoor temperature zone boundary A and B: Adjustable individually by function setting number 66 and 67.

• External heater output

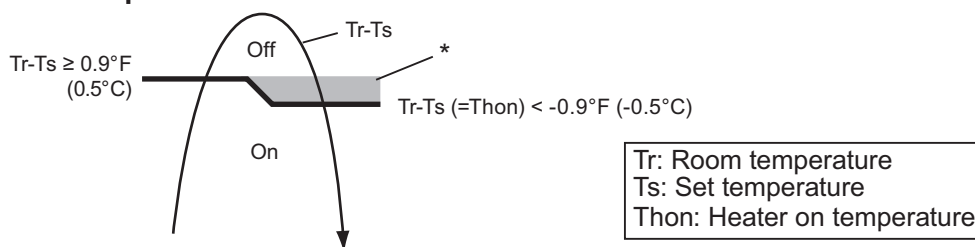

*: When room temperature stays in this zone for a specific time, auxiliary heater is turned on. For details, refer to function number 71.

• Outdoor temperature zone

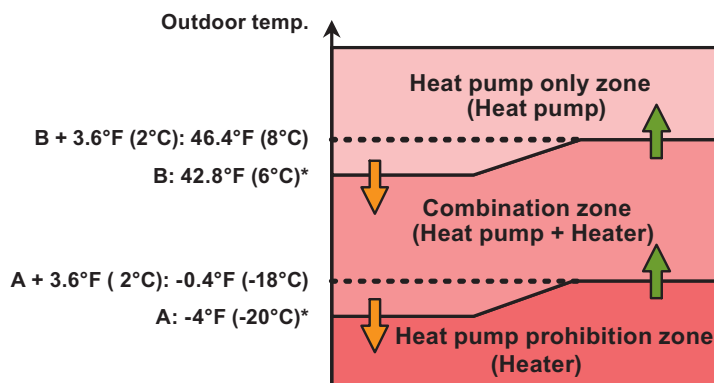

*: Adjustable by function setting 66 and 67

• Operation status

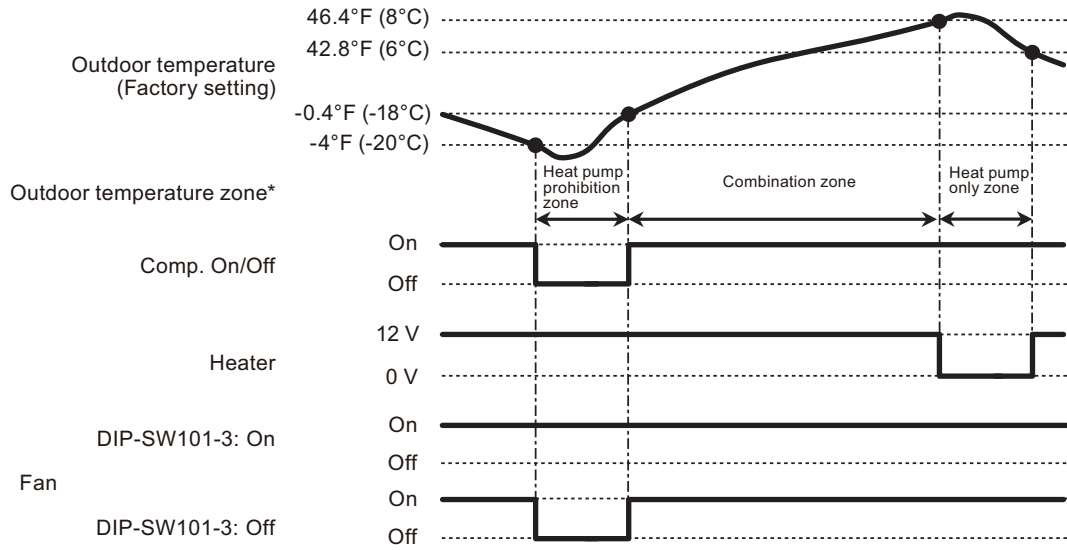

*: The outdoor temperature zone transition from one to another will stay in that zone for minimum of 30 min.

NOTE: In following operations, compressor will be on in heat pump prohibition zone.

- Other than heating
- Test run

● Auxiliary heater control by outdoor temperature 2

This control selects heat pump or external heater according to the outdoor temperature. Even when outdoor temperature is high, the heating is performed by using both of heat pump and external heater.

Operation			Condition
Heater on			Heater is on as shown in following diagram of heating temperature.
Heater off	DIP-SW101-3 Indoor unit fan setting for external heater	On Enabled	<ul style="list-style-type: none"> • Heater is off as shown in following diagram of heating temperature. • Other than heating mode • Error occurred • Forced thermostat off • Fan stop protection
	DIP-SW101-3 Indoor unit fan setting for external heater	Off Disabled	<ul style="list-style-type: none"> • Heater is off as shown in following diagram of heating temperature. • Other than heating mode • Error occurred • Forced thermostat off

- Temperature of heater on (Thon): Adjustable by function number 62 (Operating temperature switching of external heaters).
- All control temperatures will shift by adjusting “Thon”.
- Outdoor temperature zone boundary A: Adjustable by function setting number 66.

• External heater output

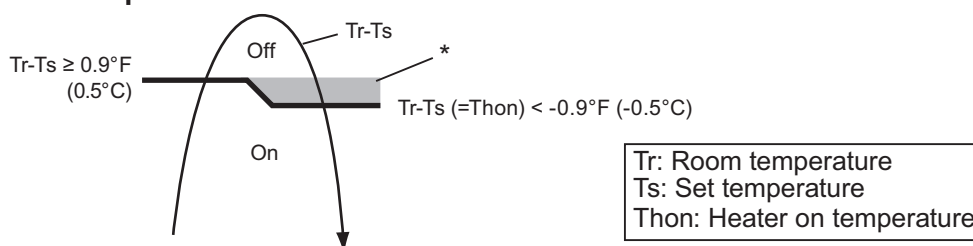

*: When room temperature stays in this zone for a specific time, auxiliary heater is turned on. For details, refer to function number 71.

• Outdoor temperature zone

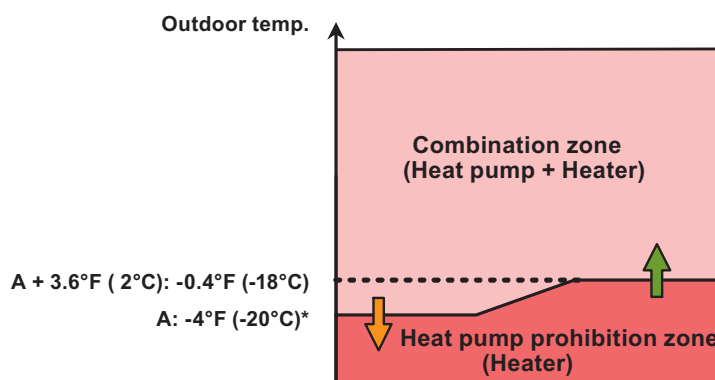

*: Adjustable by function setting 66

• Operation status

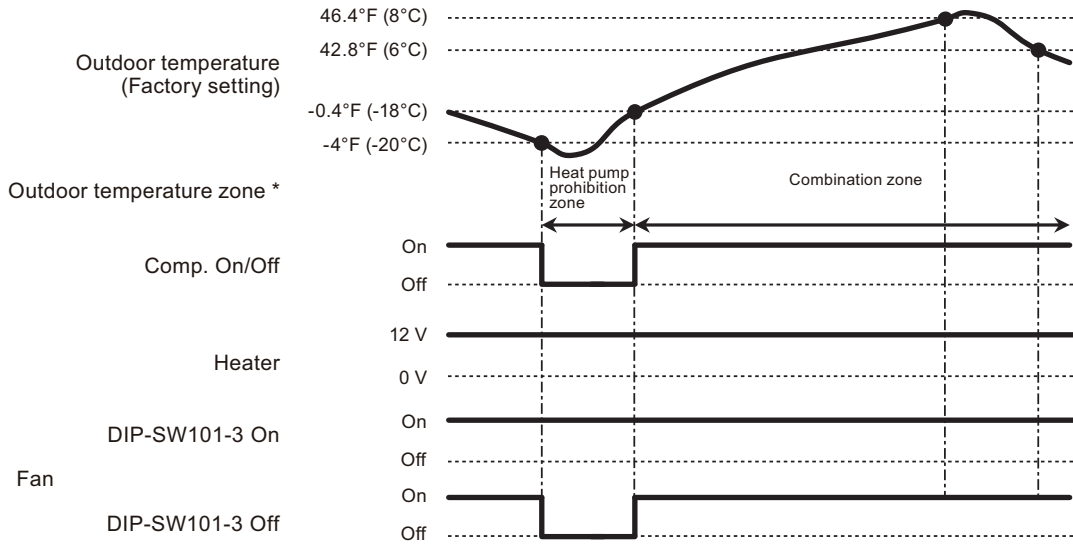

* The outdoor temperature zone transition from one to another will stay in that zone for minimum of 30 min.

NOTE: In following operations, compressor will be on in heat pump prohibition zone.

- Other than heating
- Test run

● Auxiliary heater control by outdoor temperature 3

This control selects heat pump or external heater according to the outdoor temperature. Even when outdoor temperature is high, the heating is performed by using both of heat pump and external heater.

Operation		Condition
Heater on		Heater is on as shown in following diagram of heating temperature.
Heater off	DIP-SW101-3 On Indoor unit fan setting for external heater Enabled	<ul style="list-style-type: none"> Heater is off as shown in following diagram of heating temperature. Other than heating mode Error occurred Forced thermostat off Fan stop protection
	DIP-SW101-3 Off Indoor unit fan setting for external heater Disabled	<ul style="list-style-type: none"> Heater is off as shown in following diagram of heating temperature. Other than heating mode Error occurred Forced thermostat off

- Temperature of heater on (Thon): Adjustable by function number 62 (Operating temperature switching of external heaters).
- All control temperatures will shift by adjusting “Thon”.
- Outdoor temperature zone boundary B: Adjustable by function setting number 67.

• External heater output

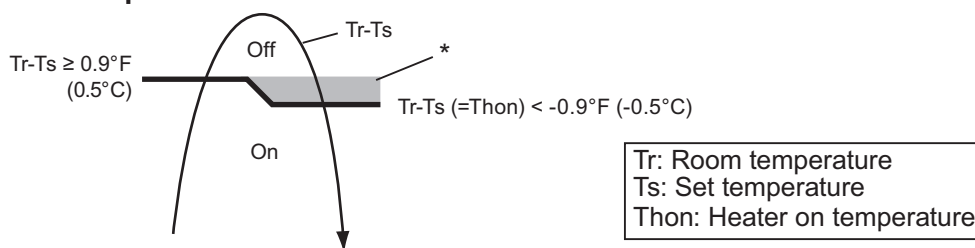

*: When room temperature stays in this zone for a specific time, auxiliary heater is turned on. For details, refer to function number 71.

• Outdoor temperature zone

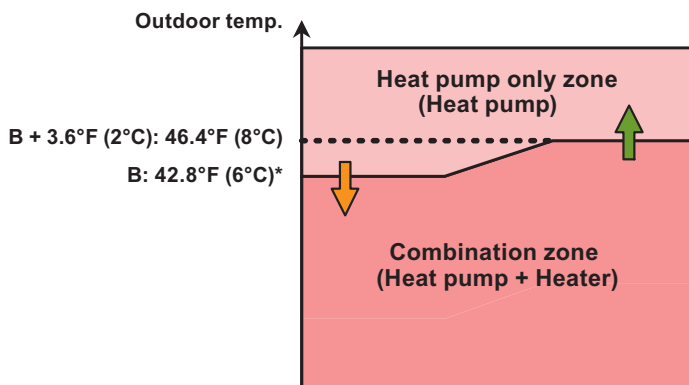

*: Adjustable by function setting 67

• Operation status

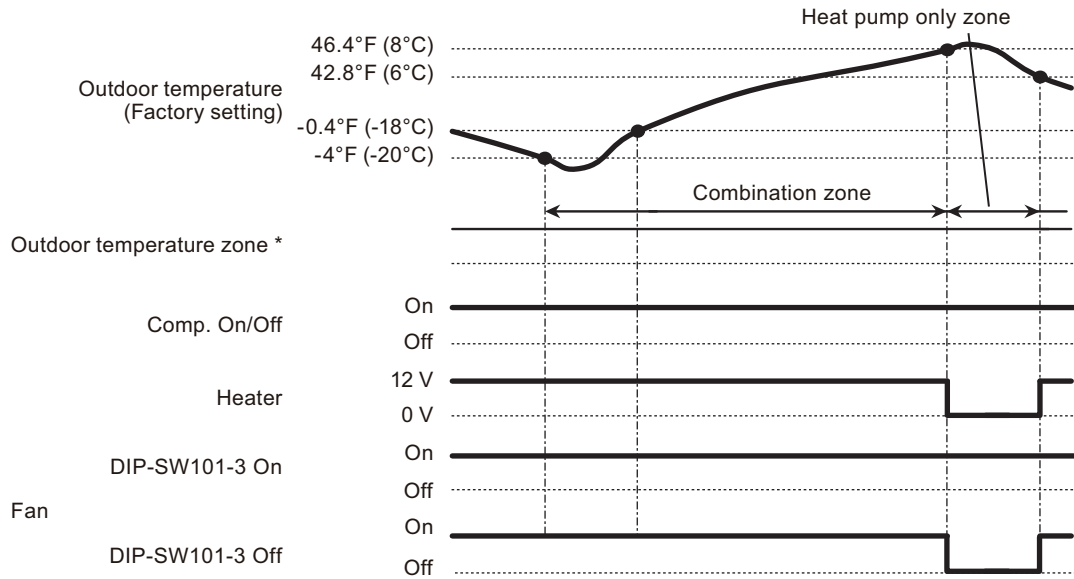

*: The outdoor temperature zone transition from one to another will stay in that zone for minimum of 30 min.

NOTE: In following operations, compressor will be on in heat pump prohibition zone.

- Other than heating
- Test run

● Auxiliary heat pump control

• External heater output

Operation			Condition
Heater on			Heater is on as shown in following diagram of heating temperature.
Heater off	DIP-SW101-3 Indoor unit fan setting for external heater	On Enabled	<ul style="list-style-type: none"> • Heater is off as shown in following diagram of heating temperature. • Other than heating mode • Error occurred • Forced thermostat off • Fan stop protection
	DIP-SW101-3 Indoor unit fan setting for external heater	Off Disabled	<ul style="list-style-type: none"> • Heater is off as shown in following diagram of heating temperature. • Other than heating mode • Error occurred • Forced thermostat off

- Temperature of heater on (Thon): Set temperature (Ts) - 0.9 °F (- 0.5 °C)
- Temperature of heater off: Set temperature (Ts) + 0.9 °F (+ 0.5 °C)

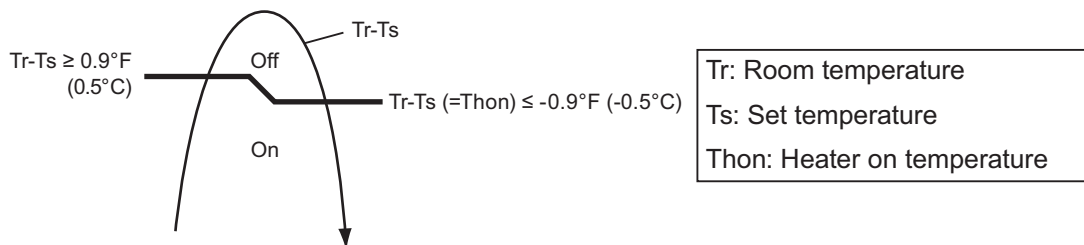

• Auxiliary heat pump On/Off

- Temperature of heater on (Thon): Adjustable by function number 62 (Operating temperature switching of heat pump).
- All control temperatures will shift by adjusting “Thon”.

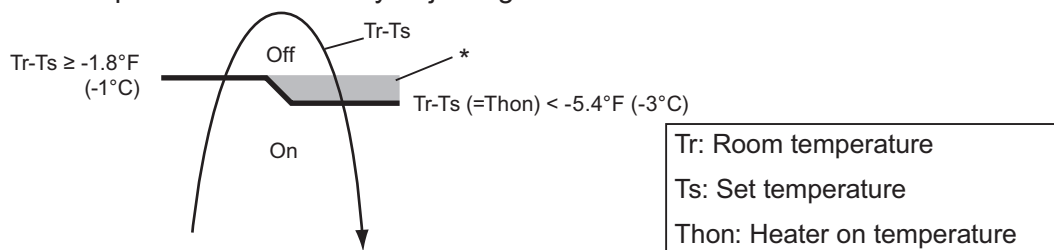

*: When room temperature stays in this zone for a specific time, auxiliary heater is turned on. For details, refer to function number 71.

● Auxiliary heat pump control by outdoor temperature 1

• External heater output

Operation		Condition
Heater on		Heater is on as shown in following diagram of heating temperature.
Heater off	DIP-SW101-3 On Indoor unit fan setting for external heater Enabled	<ul style="list-style-type: none"> • Heater is off as shown in following diagram of heating temperature. • Other than heating mode • Error occurred • Forced thermostat off • Fan stop protection
	DIP-SW101-3 Off Indoor unit fan setting for external heater Disabled	<ul style="list-style-type: none"> • Heater is off as shown in following diagram of heating temperature. • Other than heating mode • Error occurred • Forced thermostat off

- Temperature of heater on (Thon): Set temperature (Ts) - 0.9 °F (- 0.5 °C)
- Temperature of heater off: Set temperature (Ts) + 0.9 °F (+ 0.5 °C)

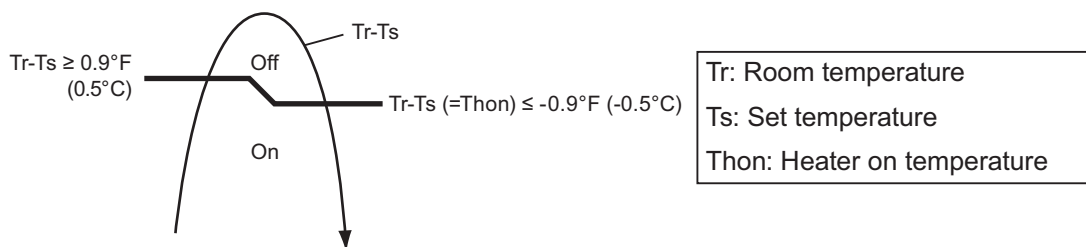

• Auxiliary heat pump On/Off

- Temperature of heater on (Thon): Adjustable by function number 62 (Operating temperature switching of heat pump).
- All control temperatures will shift by adjusting “Thon”.

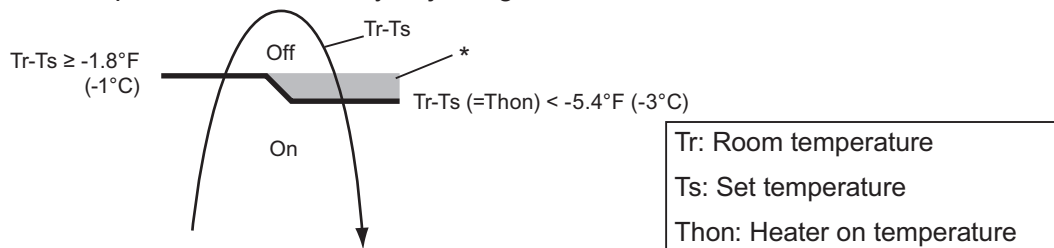

*: When room temperature stays in this zone for a specific time, auxiliary heater is turned on. For details, refer to function number 71.

• Outdoor temperature zone

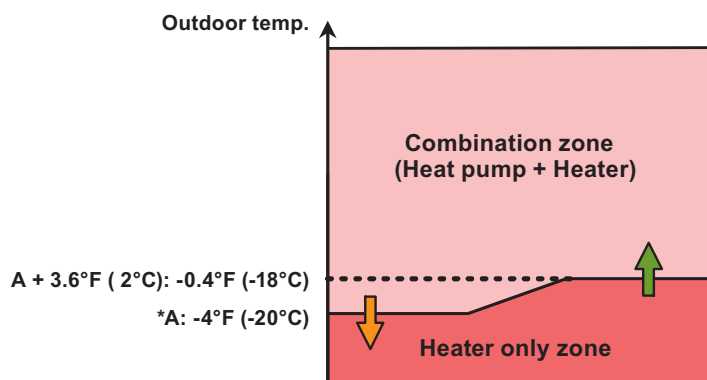

*: Adjustable by function setting 67

• Operation status

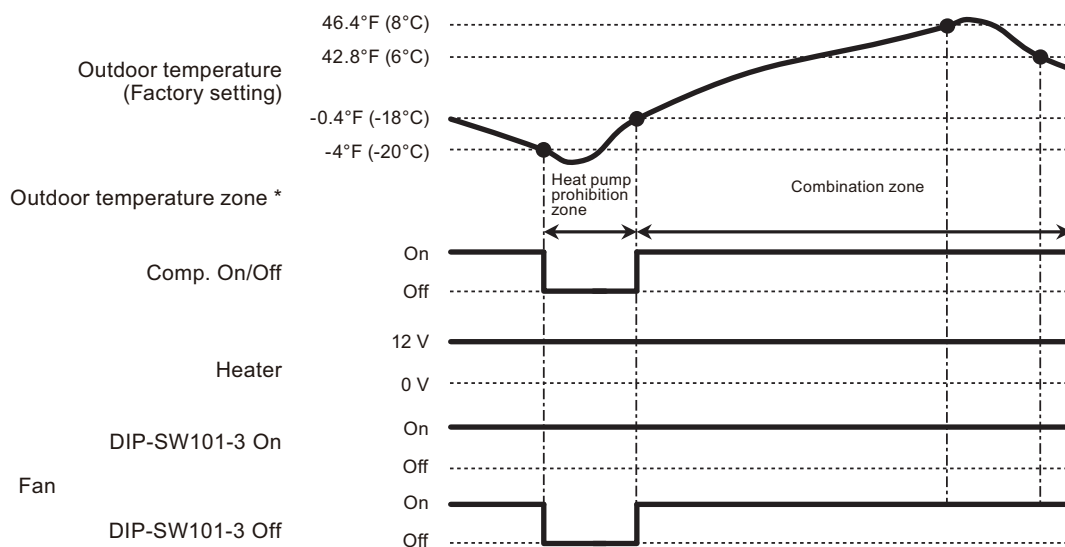

* The outdoor temperature zone transition from one to another will stay in that zone for minimum of 30 min.

NOTE: In following operations, compressor will be on in heat pump prohibition zone.

- Other than heating
- Test run

● Auxiliary heat pump control by outdoor temperature 2

• External heater output

Operation			Condition
Heater on			Heater is on as shown in following diagram of heating temperature.
Heater off	DIP-SW101-3 Indoor unit fan setting for external heater	On Enabled	<ul style="list-style-type: none"> • Heater is off as shown in following diagram of heating temperature. • Other than heating mode • Error occurred • Forced thermostat off • Fan stop protection
	DIP-SW101-3 Indoor unit fan setting for external heater	Off Disabled	<ul style="list-style-type: none"> • Heater is off as shown in following diagram of heating temperature. • Other than heating mode • Error occurred • Forced thermostat off

- Temperature of heater on (Thon): Set temperature (Ts) - 0.9 °F (- 0.5 °C)
- Temperature of heater off: Set temperature (Ts) + 0.9 °F (+ 0.5 °C)

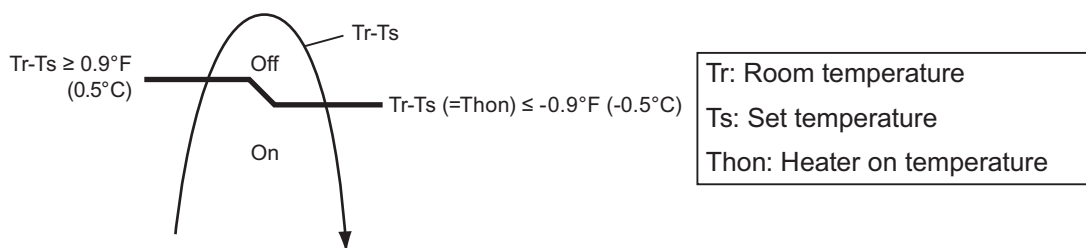

• Auxiliary heat pump On/Off

- Temperature of heater on (Thon): Adjustable by function number 62 (Operating temperature switching of heat pump).
- All control temperatures will shift by adjusting “Thon”.

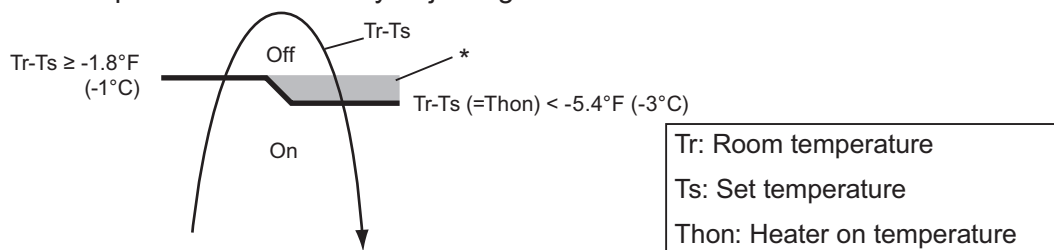

*: When room temperature stays in this zone for a specific time, auxiliary heater is turned on. For details, refer to function number 71.

• Outdoor temperature zone

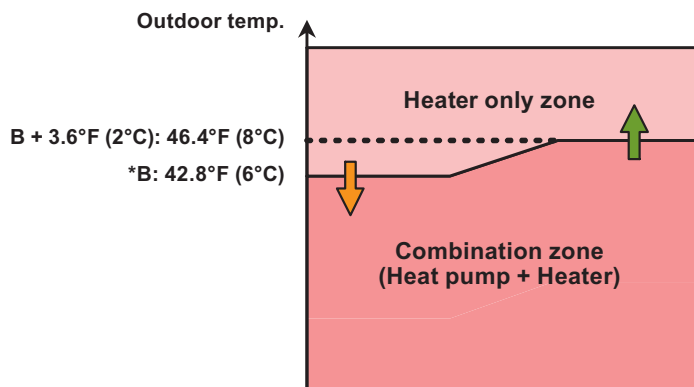

*: Adjustable by function setting 67

• Operation status

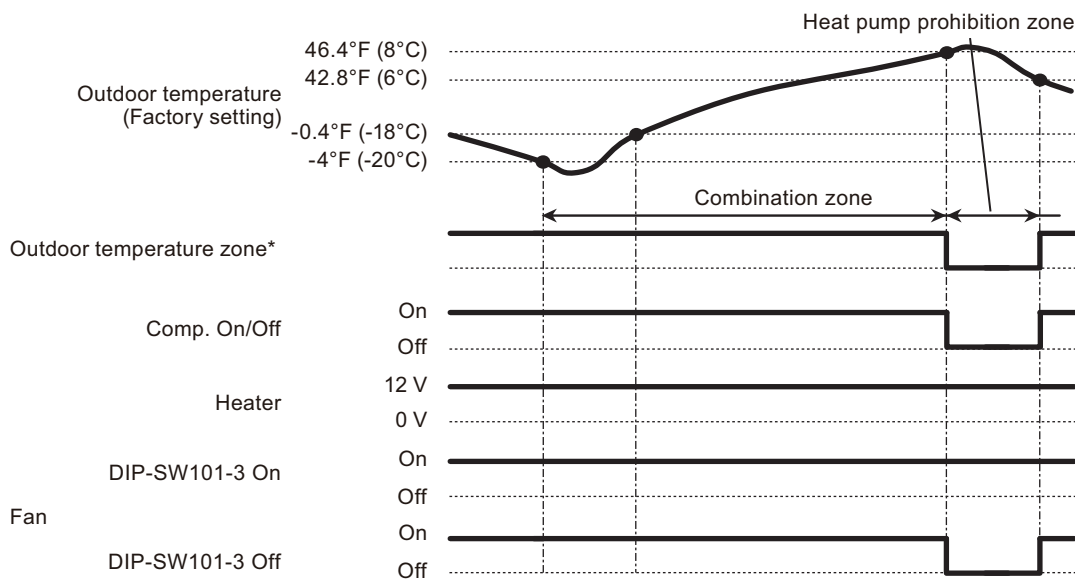

*: The outdoor temperature zone transition from one to another will stay in that zone for minimum of 30 min.

NOTE: In following operations, compressor will be on in heat pump prohibition zone.

- Other than heating
- Test run

● Auxiliary heat pump control by outdoor temperature 3

• External heater output

Operation			Condition
Heater on			Heater is on as shown in following diagram of heating temperature.
Heater off	DIP-SW101-3 Indoor unit fan setting for external heater	On Enabled	<ul style="list-style-type: none"> • Heater is off as shown in following diagram of heating temperature. • Other than heating mode • Error occurred • Forced thermostat off • Fan stop protection
	DIP-SW101-3 Indoor unit fan setting for external heater	Off Disabled	<ul style="list-style-type: none"> • Heater is off as shown in following diagram of heating temperature. • Other than heating mode • Error occurred • Forced thermostat off

- Temperature of heater on (Thon): Set temperature (Ts) - 0.9 °F (- 0.5 °C)
- Temperature of heater off: Set temperature (Ts) + 0.9 °F (+ 0.5 °C)

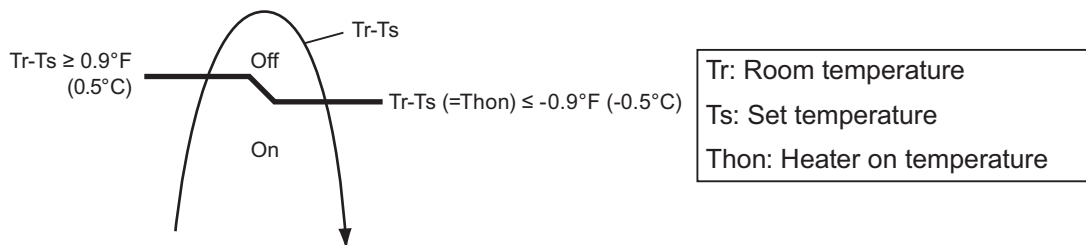

• Auxiliary heat pump On/Off

- Temperature of heater on (Thon): Adjustable by function number 62 (Operating temperature switching of heat pump).
- All control temperatures will shift by adjusting “Thon”.

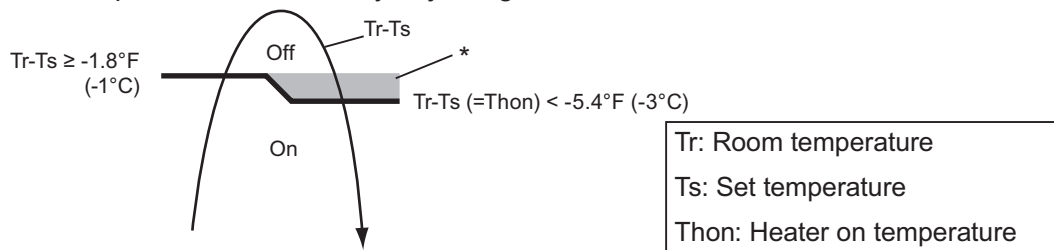

*: When room temperature stays in this zone for a specific time, auxiliary heater is turned on. For details, refer to function number 71.

• Outdoor temperature zone

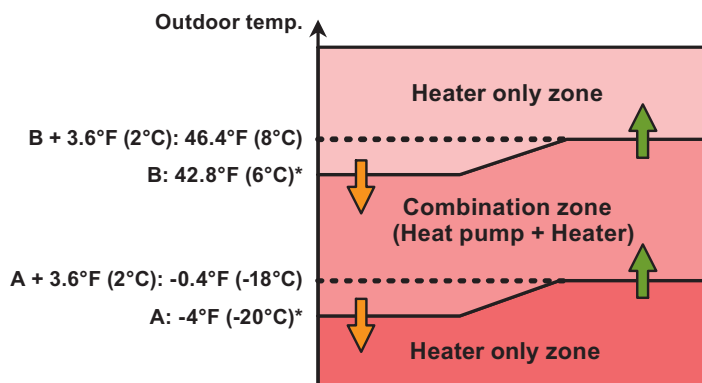

*: Adjustable by function setting 66 and 67

• Operation status

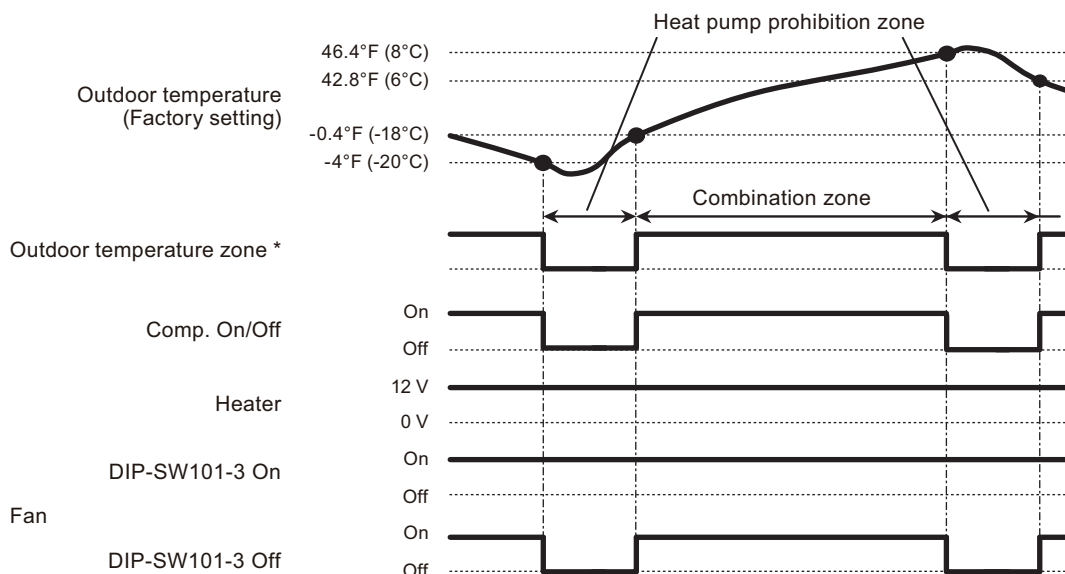

* The outdoor temperature zone transition from one to another will stay in that zone for minimum of 30 min.

NOTE: In following operations, compressor will be on in heat pump prohibition zone.

- Other than heating
- Test run

■ Heating thermostat on for humidifier

Situation	Indoor unit				
	Mode	Function setting	Rotary SW	External output	
		Heating thermostat on no. 60		Heating thermostat on	Indoor unit fan operation status
Example of individual connection	5	60-05	7	CN47	Not used
	6	60-06	8	Output3	
	7	60-07	9	Output2	
	8	60-08	A	Output1	

- **Example of individual connection**

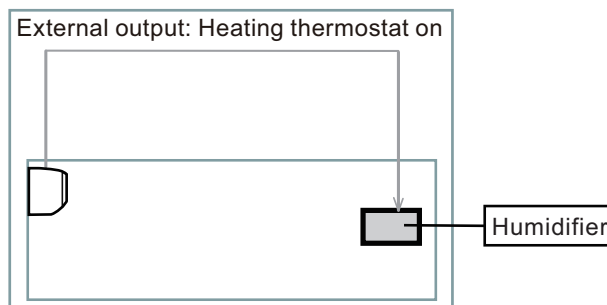

- **Operation status**

The heating thermostat output for CN47, Output1, Output2, and Output3 will be on when comp on or external heater on.

The heating thermostat output will be off when comp off and external heater off.

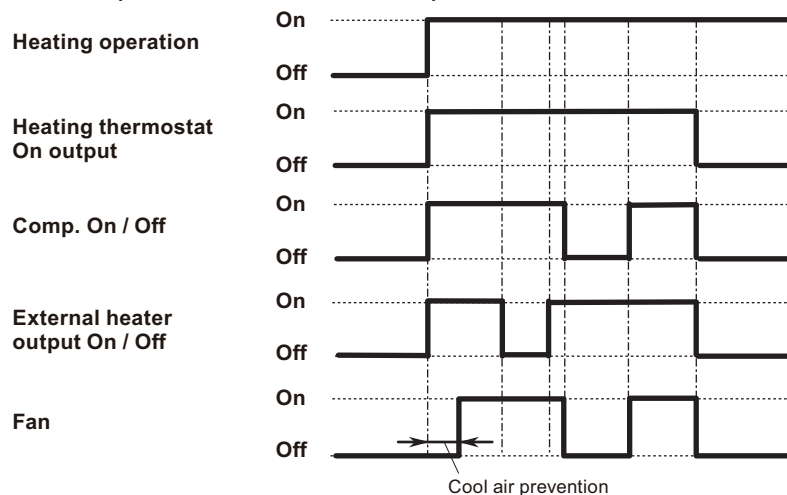

9. Function settings

To adjust the functions of this product according to the installation environment, various types of function settings are available.

NOTE: Incorrect settings can cause a product malfunction.

9-1. Function settings on indoor unit

By using some components on the PCB, you can change the function settings.

Related components on the PCB and the applicable settings:

Component		Setting content	
DIP switch	SW101	1	Drainage function setting
		2	Auto louver grille setting
		3	Fan delay setting

■ Component location

Components on the indoor unit main PCB used for the function settings are located as shown in the following figure.

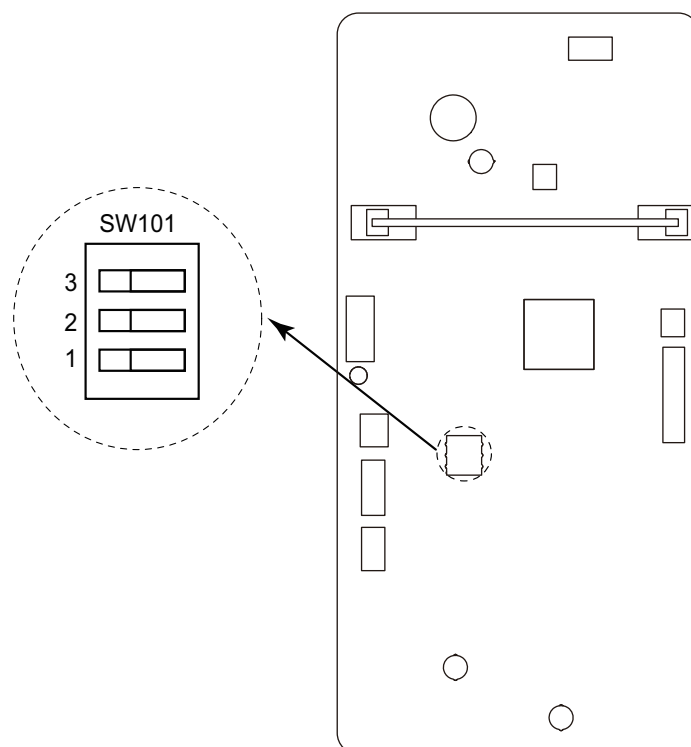

■ DIP switch setting

- **SW101-Switch 1: Drainage function setting**

Switch 1	Drainage function	Factory setting
ON	Disabled	
OFF	Enabled	◆

- **SW101-Switch 2: Auto louver grille setting**

When Auto louver grille kit (optional parts) is attached, set to "Enabled".

Switch 2	Auto louver grille setting	Factory setting
ON	Enabled	
OFF	Disabled	◆

- **SW101-Switch 3: Fan delay setting**

When the indoor unit is stopped while operating in conjunction with auxiliary heater, the indoor unit fan operation will continue for 1 minute.

Switch 3	Fan delay	Factory setting
ON	Enabled	
OFF	Disabled	◆

9-2. Function settings by using remote controller

Some function settings can be changed on the remote controller. After confirming the setting procedure and the content of each function setting, select appropriate functions for your installation environment.

■ Setting procedure by using remote controller

Remote controller is not attached for this product. For details of the installing remote controller, refer to following information.

- Overview information: Operating manual of the remote controller
- Setting procedure: Installation manual of the remote controller

■ Contents of function setting

Each function setting listed in this section is adjustable in accordance with the installation environment.

NOTE: Setting will not be changed if invalid numbers or setting values are selected.

● Function setting list

	Function no.	Functions
1)	11	Filter sign
2)	26	Static pressure
3)	30/31	Room temperature control for indoor unit sensor
4)	35/36	Room temperature control for wired remote controller sensor
5)	40	Auto restart
6)	42	Room temperature sensor switching
7)	44	Remote controller custom code
8)	46	External input control
9)	48	Room temperature sensor switching (Aux.)
10)	49	Indoor unit fan control for energy saving for cooling
11)	60	Switching functions for external output terminal
12)	61	Control switching of external heaters
13)	62	Operating temperature switching of external heaters
14)	66	Outdoor temperature zone boundary temperature A
15)	67	Outdoor temperature zone boundary temperature B
16)	71	Standby time for auxiliary equipment operation
17)	72	Heat pump backup setting
18)	73	Emergency heat for external output terminal
19)	74	Fan delay time
20)	75	External heater use in defrosting

1) Filter sign

Select appropriate intervals for displaying the filter sign on the indoor unit according to the estimated amount of dust in the air of the room.

If the indication is not required, select "No indication" (03).

Function number	Setting value	Setting description	Factory setting
11	00	Standard (400 hours)	
	01	Long interval (1,000 hours)	
	02	Short interval (200 hours)	
	03	No indication	◆

2) Static pressure

Select the appropriate static pressure according to the installation conditions.

Function number	Setting value	Setting description	Factory setting
26	00	0 in.WG (0 Pa)	
	01	0.04 in.WG (10 Pa)	
	02	0.08 in.WG (20 Pa)	
	03	0.12 in.WG (30 Pa)	
	04	0.16 in.WG (40 Pa)	
	05	0.20 in.WG (50 Pa)	
	06	0.24 in.WG (60 Pa)	
	07	0.28 in.WG (70 Pa)	
	08	0.32 in.WG (80 Pa)	
	09	0.36 in.WG (90 Pa)	
	31	Standard (0.10 in.WG [25 Pa])	◆

3) Room temperature control for indoor unit sensor

Depending on the installed environment, correction of the room temperature sensor may be required. Select the appropriate control setting according to the installed environment.

The temperature of the room temperature sensor is corrected as follows:

Corrected temp. = Temp. of the room temp. sensor - Correction temp. value

Example of correction:

When the temperature of the room temp. sensor is 78°F and the setting value is "03" (-2°F), the corrected temp. will be 80°F (78°F - [-2°F]).

The temperature correction values show the difference from the Standard setting "00" (manufacturer's recommended value).

Function number	Setting value	Setting description	Factory setting		
30 (For cooling)	31 (For heating)	00	Standard setting	◆	
		01	No correction 0.0 °F (0.0 °C)		
		02	-1 °F (-0.5 °C)	More cooling Less heating	
		03	-2 °F (-1.0 °C)		
		04	-3 °F (-1.5 °C)		
		05	-4 °F (-2.0 °C)		
		06	-5 °F (-2.5 °C)		
		07	-6 °F (-3.0 °C)		
		08	-7 °F (-3.5 °C)		
		09	-8 °F (-4.0 °C)		
		10	+1 °F (+0.5 °C)	Less cooling More heating	
		11	+2 °F (+1.0 °C)		
		12	+3 °F (+1.5 °C)		
		13	+4 °F (+2.0 °C)		
		14	+5 °F (+2.5 °C)		
		15	+6 °F (+3.0 °C)		
		16	+7 °F (+3.5 °C)		
17	+8 °F (+4.0 °C)				

4) Room temperature control for wired remote controller sensor

Depending on the installed environment, correction of the wire remote temperature sensor may be required. Select the appropriate control setting according to the installed environment.

To change this setting, set Function 42 to "Both" (01).

Ensure that the Thermo Sensor icon is displayed on the remote controller screen.

Function number		Setting value	Setting description	Factory setting	
35 (For cooling)	36 (For heating)	00	Standard setting	◆	
		01	No correction 0.0 °F (0.0 °C)		
		02	-1 °F (-0.5 °C)	More cooling Less heating	
		03	-2 °F (-1.0 °C)		
		04	-3 °F (-1.5 °C)		
		05	-4 °F (-2.0 °C)		
		06	-5 °F (-2.5 °C)		
		07	-6 °F (-3.0 °C)		
		08	-7 °F (-3.5 °C)		
		09	-8 °F (-4.0 °C)		
		10	+1 °F (+0.5 °C)	Less cooling More heating	
		11	+2 °F (+1.0 °C)		
		12	+3 °F (+1.5 °C)		
		13	+4 °F (+2.0 °C)		
		14	+5 °F (+2.5 °C)		
		15	+6 °F (+3.0 °C)		
		16	+7 °F (+3.5 °C)		
17	+8 °F (+4.0 °C)				

5) Auto restart

Enables or disables automatic restart after a power interruption.

Function number	Setting value	Setting description	Factory setting
40	00	Enable	◆
	01	Disable	

NOTE: Auto restart is an emergency function such as for power outage etc. Do not attempt to use this function in normal operation. Be sure to operate the unit by remote controller or external device.

6) Room temperature sensor switching

(Only for wired remote controller)

When using the wired remote controller temperature sensor, change the setting to "Both" (01).

Function number	Setting value	Setting description	Factory setting
42	00	Indoor unit	◆
	01	Both	

00: Sensor on the indoor unit is active.

01: Sensors on both indoor unit and wired remote controller are active.

NOTE: Remote controller sensor must be turned on by using the remote controller.

7) Remote controller custom code

(Only for wireless remote controller)

The indoor unit custom code can be changed. Select the appropriate custom code.

Function number	Setting value	Setting description	Factory setting
44	00	A	◆
	01	B	
	02	C	
	03	D	

8) External input control

"Operation/Stop" mode or "Forced stop" mode can be selected.

Function number	Setting value	Setting description	Factory setting
46	00	Operation/Stop mode 1	◆
	01	(Setting prohibited)	
	02	Forced stop mode	
	03	Operation/Stop mode 2	

9) Room temperature sensor switching (Aux.)

To use the temperature sensor on the wired remote controller only, change the setting to "Wired remote controller" (01).

This function will only work if the function setting 42 is set at "Both" (01).

When the setting value is set to "Both" (00), more suitable control of the room temperature is possible by setting function setting 30 and 31 too.

Function number	Setting value	Setting description	Factory setting
48	00	Both	
	01	Wired remote controller	◆

10) Indoor unit fan control for energy saving for cooling

Enables or disables the power-saving function by controlling the indoor unit fan rotation when the outdoor unit is stopped during cooling operation.

Function number	Setting value	Setting description	Factory setting
49	00	Disable	
	01	Enable	
	02	Remote controller	◆

00: When the outdoor unit is stopped, the indoor unit fan operates continuously following the setting on the remote controller.

01: When the outdoor unit is stopped, the indoor unit fan operates intermittently at a very low speed.

02: Enable or disable this function by remote controller setting.

NOTES:

- As the factory setting, this setting is initially invalidated.
- Set to "00" or "01" when connecting a remote controller that cannot set the Fan control for energy saving function or connecting a network converter.
To confirm if the remote controller has this setting, refer to the operating manual of each remote controller.

11) Switching functions for external output terminal

Functions of the external output terminal can be switched. For details, refer to “External input and output”.

Function number	Setting value	Setting description	Factory setting
60	00	Operation status	◆
	01—04	Cooling thermostat On	
	05	Heating operation	
	06	Operation/Stop	
	07—08	Cooling thermostat On	
	09	Error status	
	10	Fresh air control	
	11	External heater	

12) Control switching of external heaters

Sets the control method for external heater to be used.

For details, refer to “External heater output” in Chapter 8-4. ["Details of function"](#) on page 39.

Function number	Setting value	Setting description	Factory setting
61	00	Auxiliary heater control 1	◆
	01	Auxiliary heater control 2	
	02	Heat pump prohibition control	
	03	Auxiliary heater control by outdoor temperature 1	
	04	Auxiliary heater control by outdoor temperature 2	
	05	Auxiliary heater control by outdoor temperature 3	
	06	Auxiliary heat pump control	
	08	Auxiliary heat pump control by outdoor temperature 2	
	09	Auxiliary heat pump control by outdoor temperature 3	

13) Operating temperature switching of external heaters

Sets the temperature conditions when the external heater is ON.

For details, refer to "External heater output" in Chapter 8-4. ["Details of function"](#) on page 39.

Function number	Setting value	Setting description				Factory setting
		Setting value of function 61:				
		00		01 to 09		
		Heater: On	Heater: Off	Heater: On	Heater: Off	
62	00	-5.4 °F (-3 °C)	-1.8 °F (-1 °C)	-0.9 °F (-0.5 °C)	0.9 °F (0.5 °C)	◆
	01	-3.6 °F (-2 °C)	-1.8 °F (-1 °C)	-1.8 °F (-1 °C)	0.9 °F (0.5 °C)	
	02	-3.6 °F (-2 °C)	-1.8 °F (-1 °C)	-3.6 °F (-2 °C)	0.9 °F (0.5 °C)	
	03	-5.4 °F (-3 °C)	-1.8 °F (-1 °C)	-5.4 °F (-3 °C)	0.9 °F (0.5 °C)	
	04	-7.2 °F (-4 °C)	-1.8 °F (-1 °C)	-7.2 °F (-4 °C)	0.9 °F (0.5 °C)	
	05	-9.0 °F (-5 °C)	-1.8 °F (-1 °C)	-9.0 °F (-5 °C)	0.9 °F (0.5 °C)	
	06	-5.4 °F (-3 °C)	-0.9 °F (-0.5 °C)	-0.9 °F (-0.5 °C)	0 °F (0 °C)	
	07	-3.6 °F (-2 °C)	-0.9 °F (-0.5 °C)	-1.8 °F (-1 °C)	0 °F (0 °C)	
	08	-3.6 °F (-2 °C)	-0.9 °F (-0.5 °C)	-3.6 °F (-2 °C)	0 °F (0 °C)	
	09	-5.4 °F (-3 °C)	-0.9 °F (-0.5 °C)	-5.4 °F (-3 °C)	0 °F (0 °C)	
	10	-7.2 °F (-4 °C)	-0.9 °F (-0.5 °C)	-7.2 °F (-4 °C)	0 °F (0 °C)	
	11	-9.0 °F (-5 °C)	-0.9 °F (-0.5 °C)	-9.0 °F (-5 °C)	0 °F (0 °C)	
	12	-5.4 °F (-3 °C)	0 °F (0 °C)	-0.9 °F (-0.5 °C)	-0.9 °F (-0.5 °C)	
	13	-3.6 °F (-2 °C)	0 °F (0 °C)	-1.8 °F (-1 °C)	-0.9 °F (-0.5 °C)	
	14	-3.6 °F (-2 °C)	0 °F (0 °C)	-3.6 °F (-2 °C)	-0.9 °F (-0.5 °C)	
	15	-5.4 °F (-3 °C)	0 °F (0 °C)	-5.4 °F (-3 °C)	-0.9 °F (-0.5 °C)	
	16	-7.2 °F (-4 °C)	0 °F (0 °C)	-7.2 °F (-4 °C)	-0.9 °F (-0.5 °C)	
17	-9.0 °F (-5 °C)	0 °F (0 °C)	-9.0 °F (-5 °C)	-0.9 °F (-0.5 °C)		

14) Outdoor temperature zone boundary temperature A

Setting required if changing of the outdoor temperature setting for heat pump prohibition zone is required when auxiliary heater control by outdoor temperature 1 and 2 are performed on the indoor unit. For details, refer to "External heater output" in Chapter 8-4. ["Details of function"](#) on page 39.

Function number	Setting value	Setting description	Factory setting
66	00	-4.0 °F (-20 °C)	◆
	01	-0.4 °F (-18 °C)	
	02	3.2 °F (-16 °C)	
	03	6.8 °F (-14 °C)	
	04	10.4 °F (-12 °C)	
	05	14.0 °F (-10 °C)	
	06	17.6 °F (-8 °C)	
	08	24.8 °F (-4 °C)	

15) Outdoor temperature zone boundary temperature B

Setting required if changing of the outdoor temperature setting for heat pump only zone is required when auxiliary heater control by outdoor temperature 1 is performed on the indoor unit. For details, refer to "External heater output" in Chapter 8-4. "[Details of function](#)" on page 39.

Function number	Setting value	Setting description	Factory setting
67	00	42.8 °F (6 °C)	◆
	01	14.0 °F (-10 °C)	
	02	17.6 °F (-8 °C)	
	03	21.2 °F (-6 °C)	
	04	24.8 °F (-4 °C)	
	05	28.4°F (-2 °C)	
	06	32.0 °F (0 °C)	
	07	35.6 °F (2 °C)	
	08	39.2 °F (4 °C)	
	09	42.8 °F (6 °C)	
	10	46.4 °F (8 °C)	
	11	50.0 °F (10 °C)	
	12	53.6 °F (12 °C)	
	13	57.2 °F (14 °C)	
	14	60.8 °F (16 °C)	
15	64.4 °F (18 °C)		

16) Standby time for auxiliary equipment operation

Sets the standby time until the auxiliary equipment operation starts during primary equipment operation.

For details, refer to Chapter 8-4. "[Details of function](#)" on page 39.

Function number	Setting value	Setting description	Factory setting
71	00	Disable	◆
	01	1 minute	
	02	2 minutes	
	•	•	
	•	•	
	•	•	
	98	98 minutes	
	99	99 minutes	

17) Heat pump backup setting

Enables or disables the heat pump backup instruction from the outdoor unit.

This function will be usable provided that the corresponding outdoor unit is connected.

Function number	Setting value	Setting description	Factory setting
72	00	Disable	◆
	01	Enable	

18) Emergency heat for external output terminal

Enables or disables emergency heat input.

Function number	Setting value	Setting description	Factory setting
73	00	Disable	◆
	01	Enable	

NOTE: When this function is used, IR receiver unit is necessary.

19) Fan delay time

Sets the fan delay time when the heater is turned off.

Function number	Setting value	Setting description	Factory setting
74	00	1 minute	◆
	01	50 seconds	
	02	40 seconds	
	03	30 seconds	

20) External heater use in defrosting











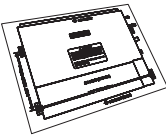

Enables or disables external heater use in defrosting.

NOTE: Inappropriate heater selection may cause cold air in defrosting.

Function number	Setting value	Setting description	Factory setting
75	00	Disable	◆
	01	Enable	

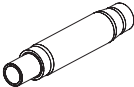
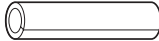
10. Accessories

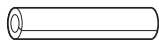
10-1. Models: ADUH09LUAS1, ADUH12LUAS1, and ADUH18LUAS1

Part name	Exterior	Q'ty	Part name	Exterior	Q'ty
Operating manual		1	Cable tie (large)		4
Installation manual		1	Cable tie (medium)		3
Installation template		1	Filter (small) [For 09/12 models]		2
Washer		8	Filter (large) [For 18 models]		2
Drain hose ($\varnothing 3/4$ in [I.D.], $\varnothing 1-1/16$ in [O.D.])		1	Coupler heat insulation (large)		1
Hose band		1	Coupler heat insulation (small)		1
Drain hose insulation B		1			





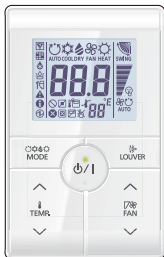
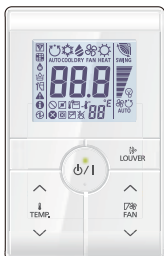
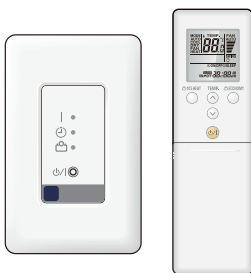

11. Optional parts



11-1. Controllers

Exterior	Part name	Model name	Summary
	Wired remote controller	UTY-RNRUZ*	Easy finger touch operation with LCD panel. Backlit LCD enables easy operation in a dark room. Wire type: Non-polar 2-wire
	Simple remote controller	UTY-RSRY	Compact remote controller concentrates on the basic functions such as Start/Stop, fan control, temperature setting, and operation mode. Wire type: Non-polar 2-wire
	Simple remote controller	UTY-RHRY	Compact remote controller concentrates on the basic functions such as Start/Stop, fan control, and temperature setting. Wire type: Non-polar 2-wire
	IR receiver kit with wireless remote controller	UTY-LBTUM	Unit control is performed by wireless remote controller.

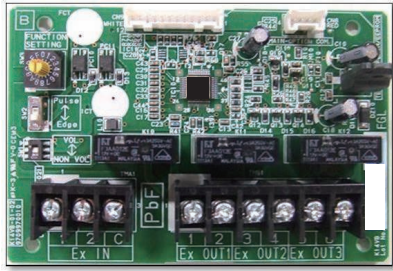
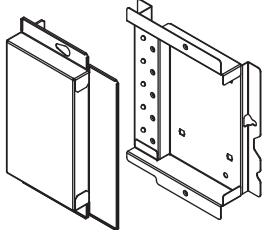
NOTE: Available functions may differ by the remote controller. For details, refer to the operation manual.

11-2. Others

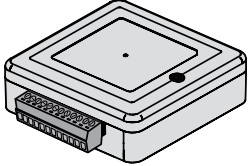
Exterior	Part name	Model name	Summary
	Remote sensor unit	UTY-XSZX	Thermo-sensor for sensing the temperature of arbitrary place in the room.
	Auto louver grille kit	UTD-GXTA-W	Width: 683 mm For 09 and 12 model
	Auto louver grille kit	UTD-GXTB-W	Width: 883 mm For 18 model
	External connect kit	UTY-XWZXZG	Use to connect with various peripheral devices and air conditioner PCB. For control output port.
	External input and output PCB	UTY-XCSX	Use to connect with external devices and air conditioner PCB.
	External input and output PCB box	UTZ-GXEA	For installing the External input and output PCB.
	Wireless LAN adapter	UTY-TFSXZ2	Remotely manage an air conditioning system using mobile devices such as smartphones and tablets. For connection indoor unit with UART interface.
	Modbus converter	UTY-VMSX	For connection between indoor unit with UART interface and a Modbus open network.

Exterior	Part name	Model name	Summary
	KNX converter	UTY-VKSX	For connection between indoor unit with UART interface and a KNX open network.
	Thermostat converter	UTY-TTRX	This converter can control Fujitsu General products using a third-party thermostat controller.
	External switch controller	UTY-TERX	Air conditioner switching can be controlled by connecting other external sensor switches.

Part 2. OUTDOOR UNIT

SINGLE TYPE:

AOUH09LUAS1

AOUH12LUAS1

AOUH18LUAS1

1. Specifications

OUTDOOR UNIT
AOUH09-18LUAS1

OUTDOOR UNIT
AOUH09-18LUAS1

Type			Inverter heat pump			
Model name			AOUH09LUAS1	AOUH12LUAS1	AOUH18LUAS1	
Power supply			208/230 V ~ 60 Hz			
Power supply intake			Outdoor unit			
Available voltage range			187—253 V			
Starting current			6.4			
Fan	Airflow rate	Cooling	CFM (m ³ /h)	906 (1,540)	1,171 (1,990)	1,395 (2,370)
		Heating			1,089 (1,850)	1,460 (2,480)
	Type × Q'ty	Motor output		Propeller fan × 1		
		W	23	49		
Sound pressure level *1	Cooling	dB (A)	44	48	52	
	Heating		48	49	55	
Heat exchanger type	Dimensions (H × W × D)	in (mm)	Main1: 19-13/16 × 34-11/16 × 11/16 (504 × 881 × 18.19) Main2: 19-13/16 × 33-1/2 × 11/16 (504 × 851 × 18.19)	Main1: 23-1/8 × 34-11/16 × 11/16 (588 × 881 × 18.19) Main2: 23-1/8 × 33-1/2 × 11/16 (588 × 851 × 18.19)		
	Fin pitch	FPI	20			
	Rows × Stages		Main1: 1 × 24 Main2: 1 × 24	Main1: 1 × 28 Main2: 1 × 28		
	Pipe type		Copper			
	Fin type	Type (Material)	Aluminum			
	Surface treatment	PC fin				
Compressor	Type		DC rotary × 1	DC twin rotary × 1		
	Motor output	W	900	1,030		
Refrigerant	Type		R410A			
	Charge	lb oz	2lbs.3oz.	2lbs.10oz.	2lbs.12oz.	
		g	1,000	1,200	1,250	
Refrigerant oil	Type		RB68			
	Amount	in ³ (cm ³)	20.7 (340)	24.4 (400)		
Enclosure	Material		Steel sheet			
	Color		Beige			
			Approximate color of Munsell 10YR 7.5/1.0			
Dimensions (H × W × D)	Net	in (mm)	21-5/16 × 31-7/16 × 11-7/16 (542 × 799 × 290)	24-7/8 × 31-7/16 × 11-7/16 (632 × 799 × 290)		
	Gross		23-11/16 × 37 × 14-3/4 (602 × 940 × 375)	27-1/4 × 37 × 14-3/4 (692 × 940 × 375)		
Weight	Net	lb (kg)	70 (32)	84 (38)	86 (39)	
	Gross		77 (35)	95 (43)		
Connection pipe	Size	Liquid	Ø 1/4 (Ø 6.35)			
		Gas	Ø 3/8 (Ø 9.52)			
	Method		Flare			
	Pre-charge length	ft (m)	49 (15)	66 (20)		
	Max. length		66 (20)	98 (30)		
Max. height difference		49 (15)				
Operation range	Cooling	°F (°C)	14 to 115 (-10 to 46)			
	Heating		-5 to 75 (-21 to 24)			
Drain hose	Material		PP			
	Tip diameter	in (mm)	Ø 1/2 (Ø 13.0) (I. D.), Ø 5/8 to 11/16 (Ø 16.0 to 16.8) (O. D.)			
NOTES:						
<ul style="list-style-type: none"> Specifications are based on the following conditions: <ul style="list-style-type: none"> Cooling: Indoor temperature of 80 °FDB (26.67 °CDB) / 67 °FWB (19.44 °CWB), and outdoor temperature of 95 °FDB (35 °CDB) / 75 °FWB (23.9 °CWB). Heating: Indoor temperature of 70 °FDB (21.11 °CDB) / 59 °FWB (15 °CWB), and outdoor temperature of 47 °FDB (8.33 °CDB) / 43 °FWB (6.11 °CWB). Pipe length: 24 ft 6 in (7.5 m), Height difference: 0 ft (0 m). (Between outdoor unit and indoor unit.) Protective function might work when using it outside the operation range. *1: Sound pressure level <ul style="list-style-type: none"> Measured values in manufacturer's anechoic chamber. Because of the surrounding sound environment, the sound levels measured in actual installation conditions might be higher than the specified values here. 						

2. Dimensions

2-1. Models: AOUH09LUAS1

Unit: in (mm)

OUTDOOR UNIT
AOUH09-18LUAS1

OUTDOOR UNIT
AOUH09-18LUAS1

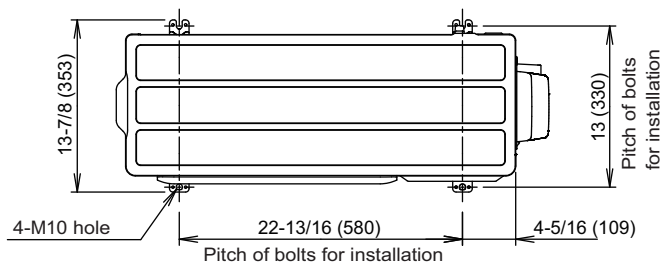

Top view

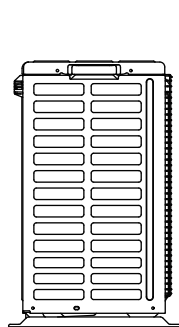

Side view

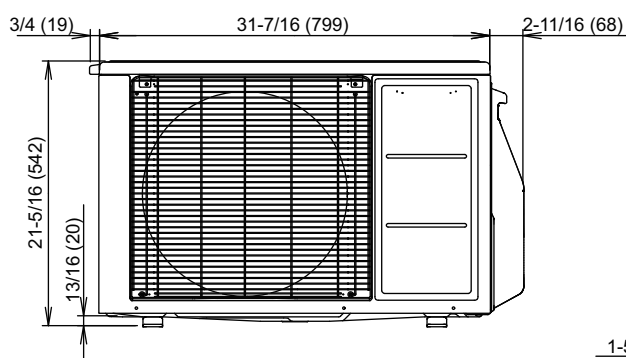

Front view

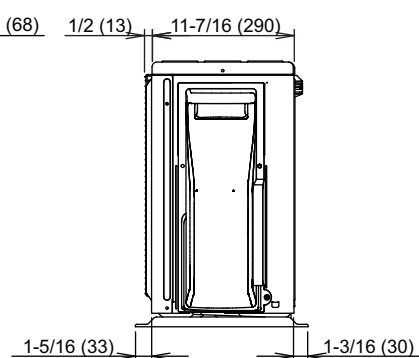

Side view

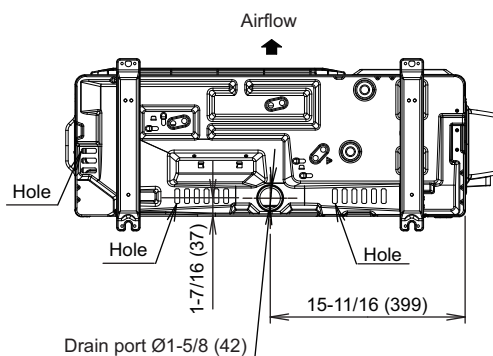

Bottom view

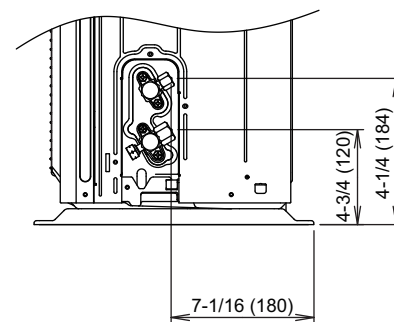

Side view (Valve part)

2-2. Models: AOUH12LUAS1 and AOUH18LUAS1

Unit: in (mm)

OUTDOOR UNIT
AOUH09-18LUAS1

OUTDOOR UNIT
AOUH09-18LUAS1

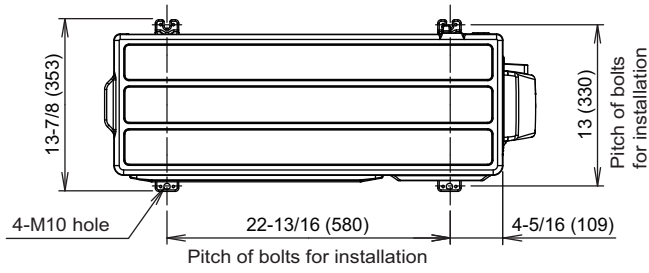

Top view

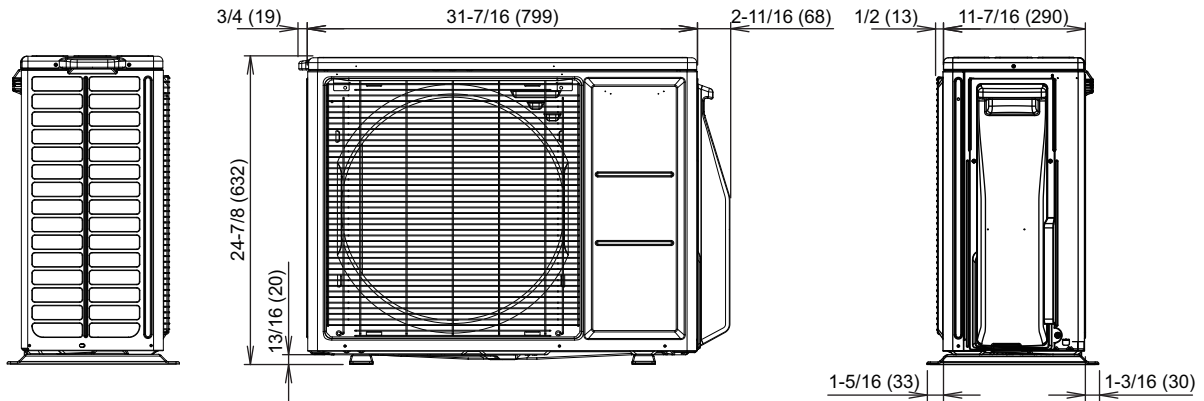

Side view

Front view

Side view

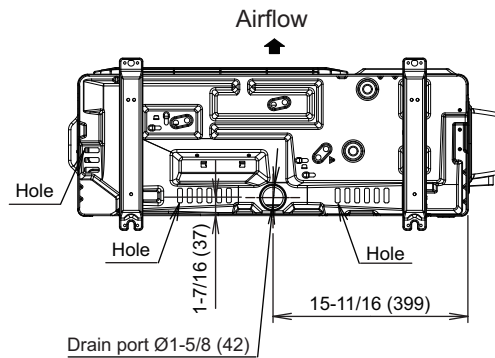

Bottom view

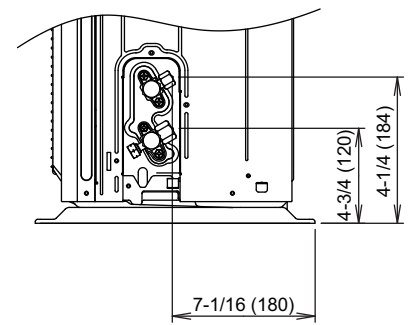

Side view (Valve part)

3. Installation space

3-1. Models: AOUH09LUAS1, AOUH12LUAS1, and AOUH18LUAS1

■ Space requirement

Provide sufficient installation space for product safety.

⚠ CAUTION

Keep the space shown in the installation examples.

If the installation is not performed accordingly, it could cause a short circuit and result in a lack of operating performance.

● Single outdoor unit installation

- When the upper space is open:

Unit: in (mm)

Obstacles at rear only

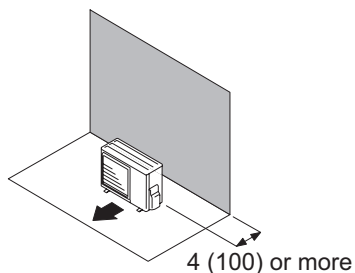

Obstacles at rear and sides

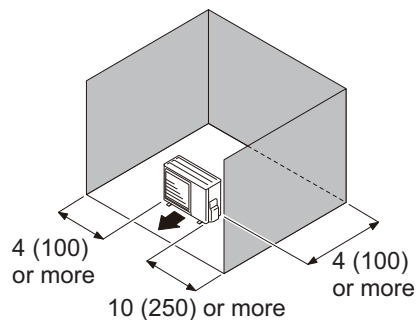

Obstacles at front

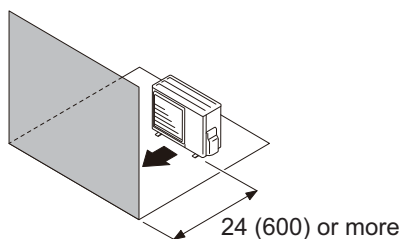

Obstacles at front and rear

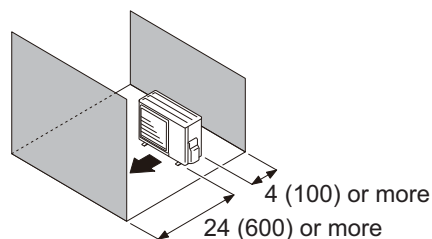

- When an obstruction in the upper space:

Unit: in (mm)

Obstacles at rear and above

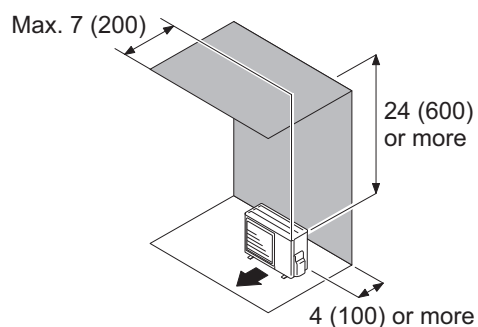

Obstacles at rear, sides, and above

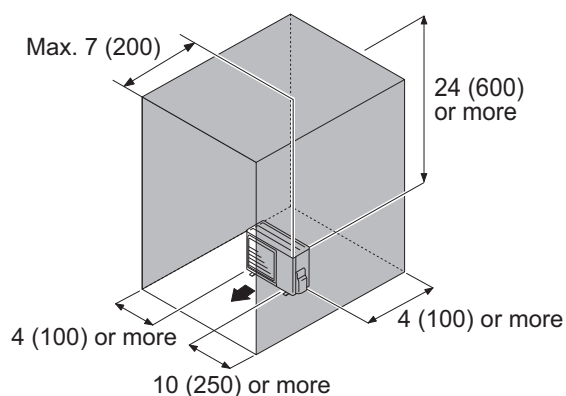

● Multiple outdoor unit installation

- Provide at least 10 in (250 mm) of space between the outdoor units if multiple units are installed.
- When routing the piping from the side of an outdoor unit, provide space for piping.
- No more than 3 units must be installed side by side. When 4 units or more are arranged in a line, provide the space as shown in the following example **“When an obstruction in the upper space:”**.
- **When the upper space is open:**

Unit: in (mm)

Obstacles at rear only

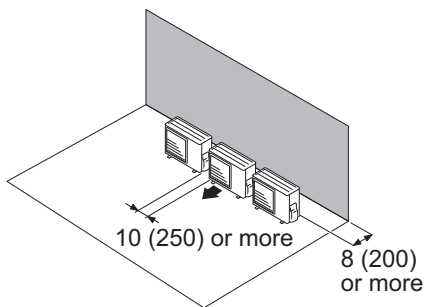

Obstacles at front only

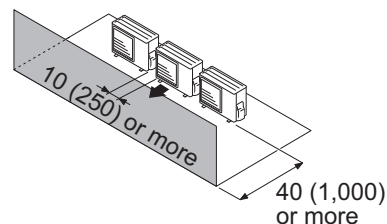

Obstacles at front and rear

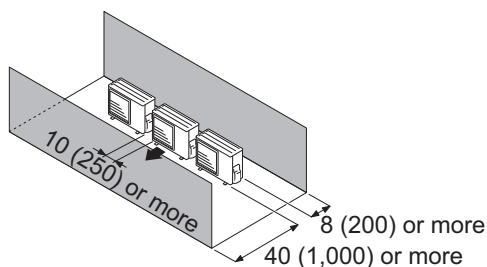

- **When an obstruction in the upper space:**

Unit: in (mm)

Obstacles at rear and above.

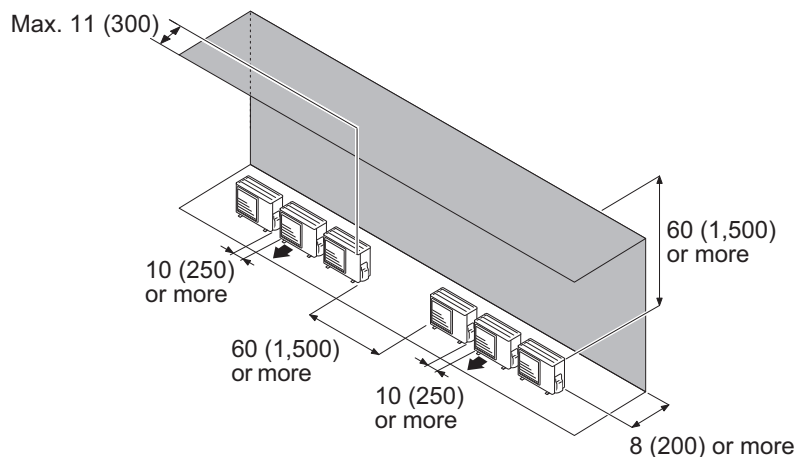

● Outdoor units installation in multi-row

Unit: in (mm)

Single parallel unit arrangement

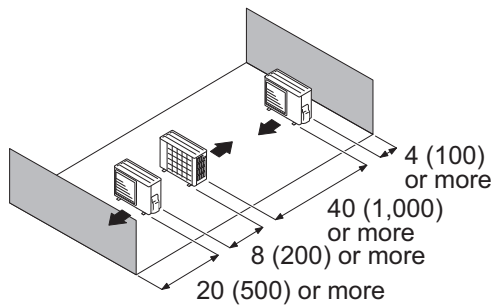

Multiple parallel unit arrangement

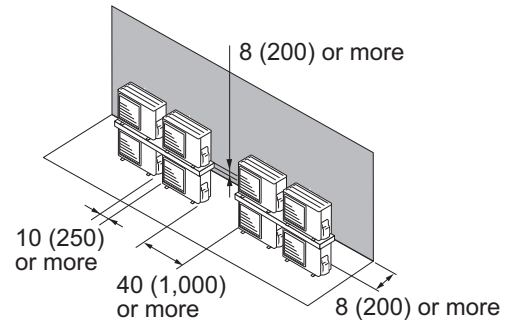
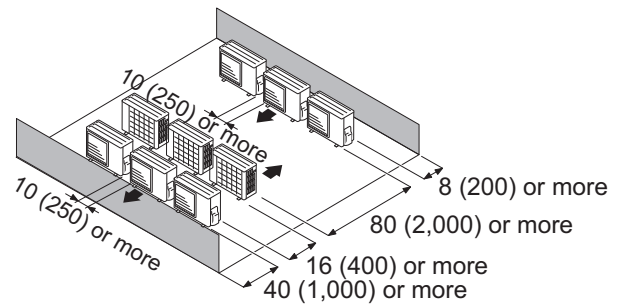

NOTES:

- If the space is larger than stated above, the condition will be the same as when there is no obstacle.
- When installing the outdoor unit, be sure to open the front and left side to obtain better operation efficiency.

⚠ CAUTION

- Do not install the outdoor unit in two-stage where the drain water could freeze. Otherwise the drainage from the upper unit may form ice and cause a malfunction of the lower unit.
- When the outdoor temperature is 32 °F (0 °C) or less, do not use the accessory drain pipe and drain cap. If the drain pipe and drain cap are used, the drain water in the pipe may freeze in extremely cold climate. (For reverse cycle model only.)
- In area with heavy snowfall, if the inlet and outlet of the outdoor unit is blocked with snow, it might become difficult to get warm, and it is likely to cause product malfunction. Construct a canopy and a pedestal, or place the unit on a high stand that is locally installed.

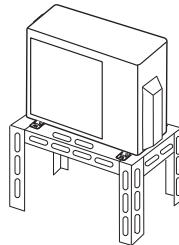

4. Refrigerant circuit

4-1. Models: AOUH09LUAS1

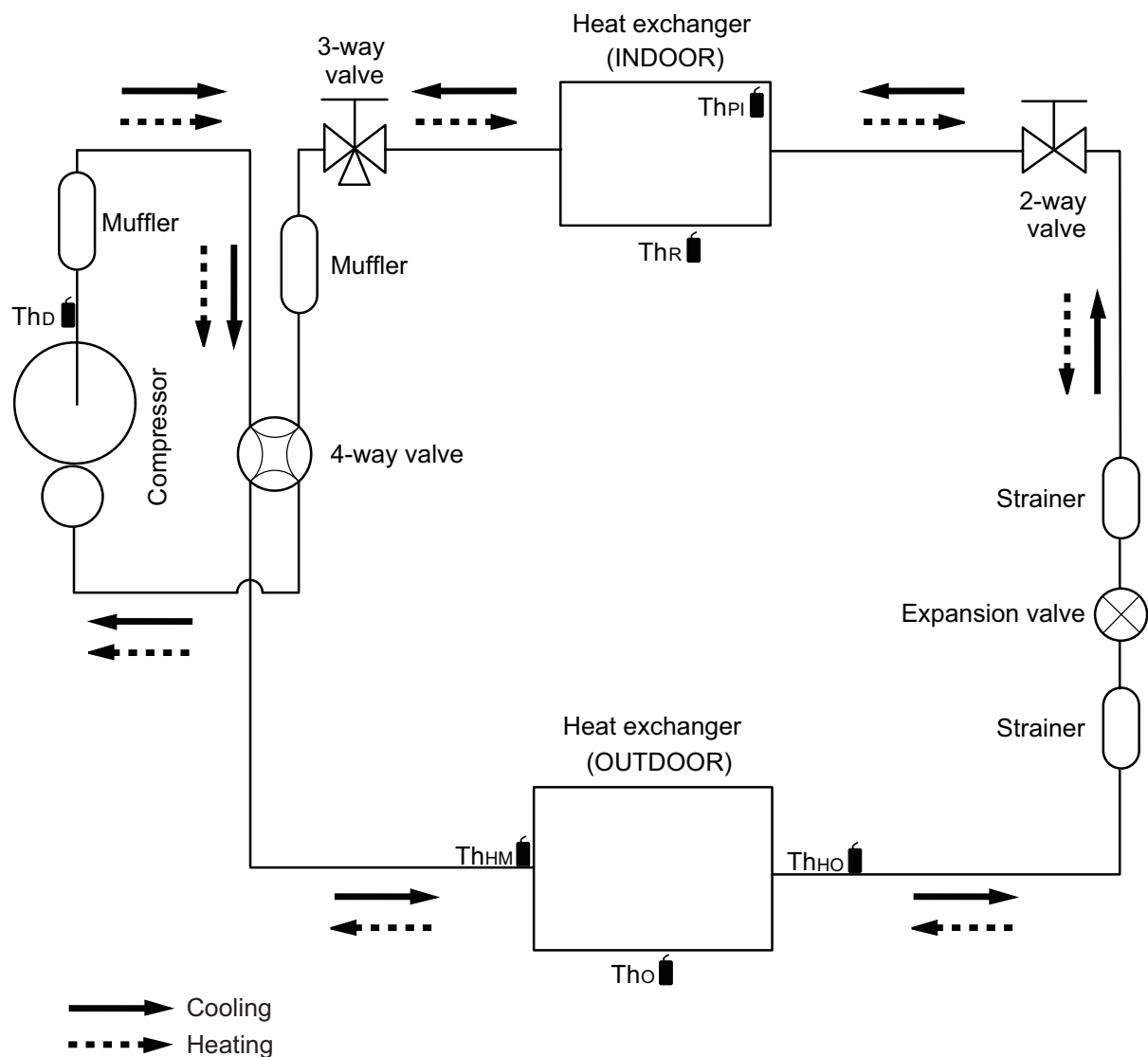

Th_D : Thermistor (Discharge temperature)

Th_O : Thermistor (Outdoor temperature)

Th_{HO} : Thermistor (Heat exchanger out temperature)

Th_{HM} : Thermistor (Heat exchanger middle temperature)

Th_R : Thermistor (Room temperature)

Th_{PI} : Thermistor (Pipe temperature)

4-2. Models: AOUH12LUAS1 and AOUH18LUAS1

OUTDOOR UNIT
AOUH09-18LUAS1

OUTDOOR UNIT
AOUH09-18LUAS1

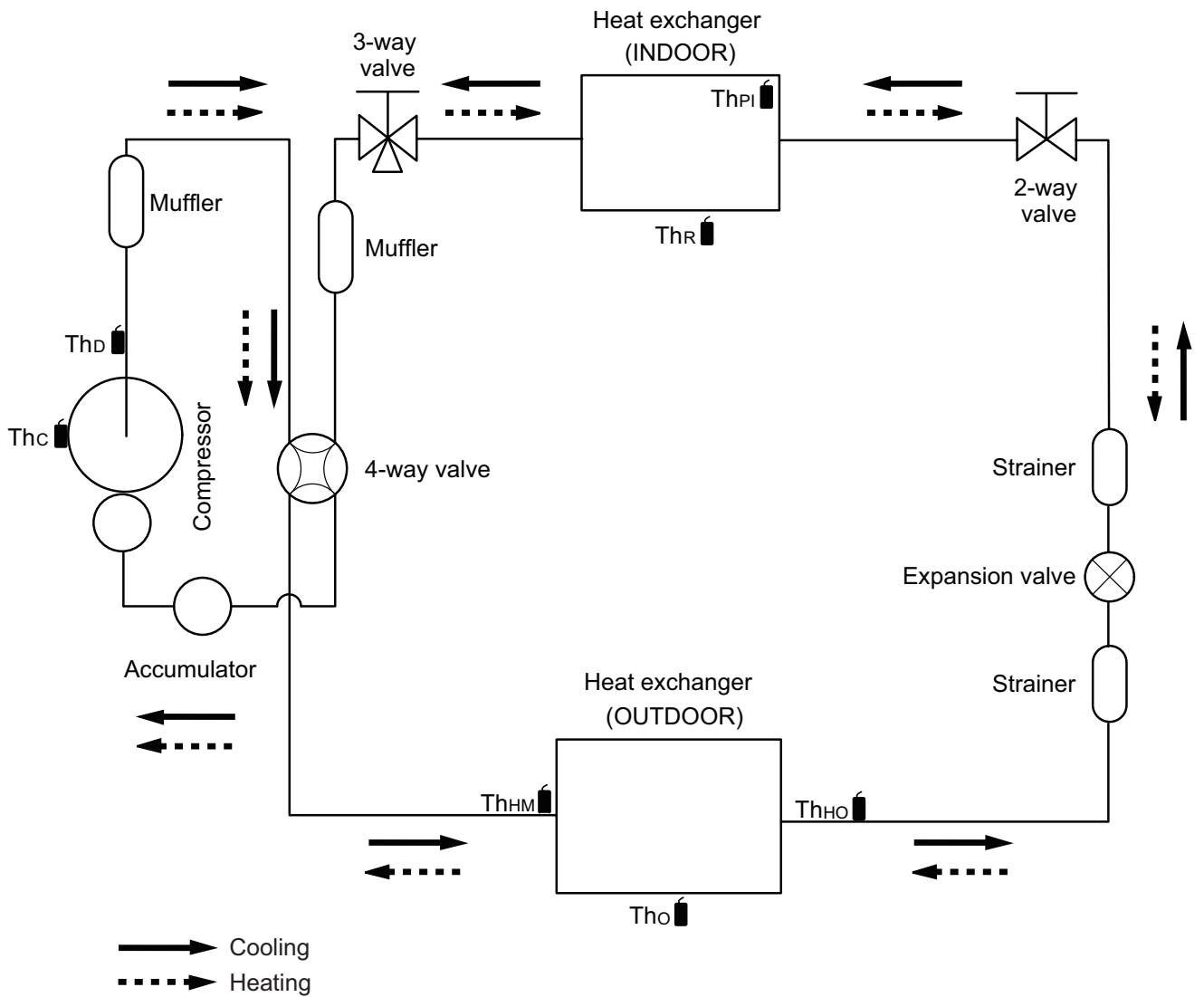

- Thc : Thermistor (Compressor temperature)
- Thd : Thermistor (Discharge temperature)
- Tho : Thermistor (Outdoor temperature)
- Thm : Thermistor (Heat exchanger middle temperature)
- Tho : Thermistor (Heat exchanger out temperature)
- ThR : Thermistor (Room temperature)
- ThPI : Thermistor (Pipe temperature)

5. Wiring diagrams

5-1. Model: AOUH09LUAS1

OUTDOOR UNIT
AOUH09-18LUAS1

OUTDOOR UNIT
AOUH09-18LUAS1

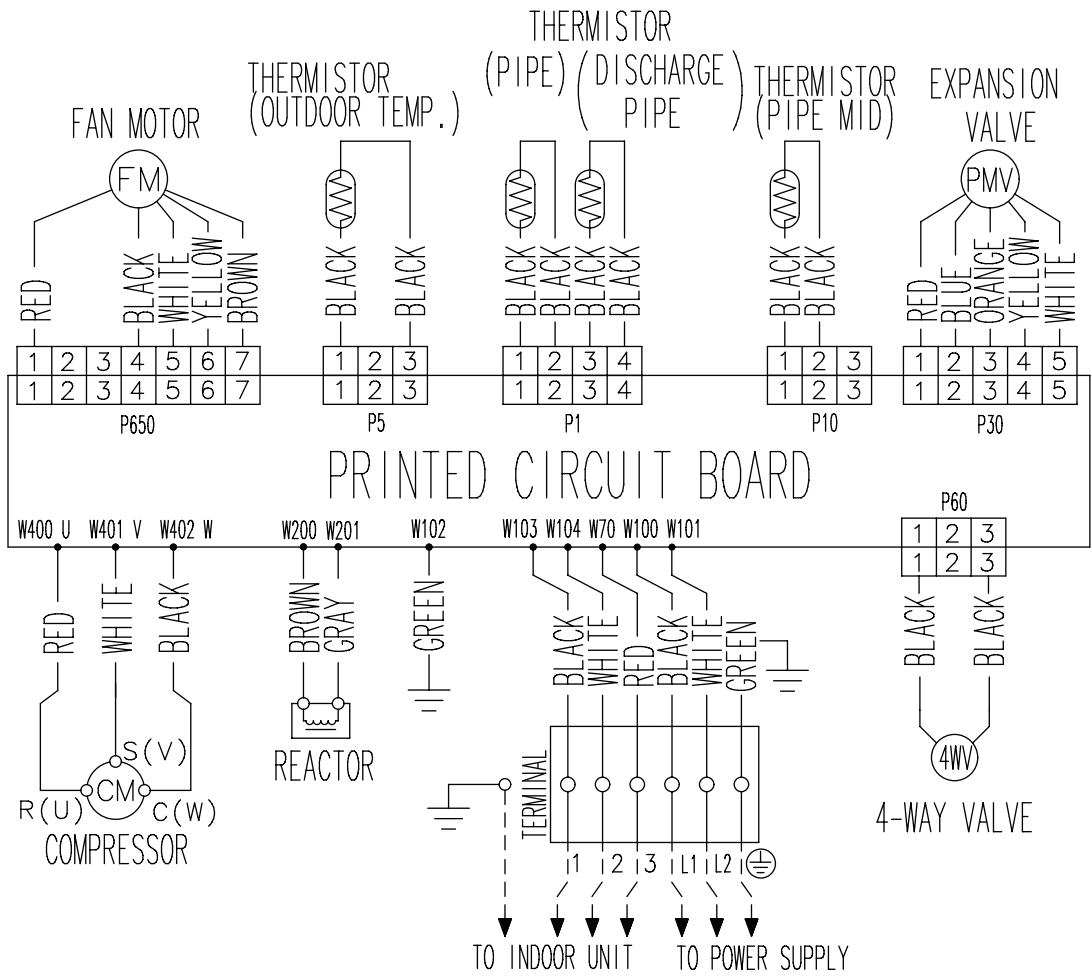

5-2. Models: AOUH12LUAS1 and AOUH18LUAS1

OUTDOOR UNIT
AOUH09-18LUAS1

OUTDOOR UNIT
AOUH09-18LUAS1

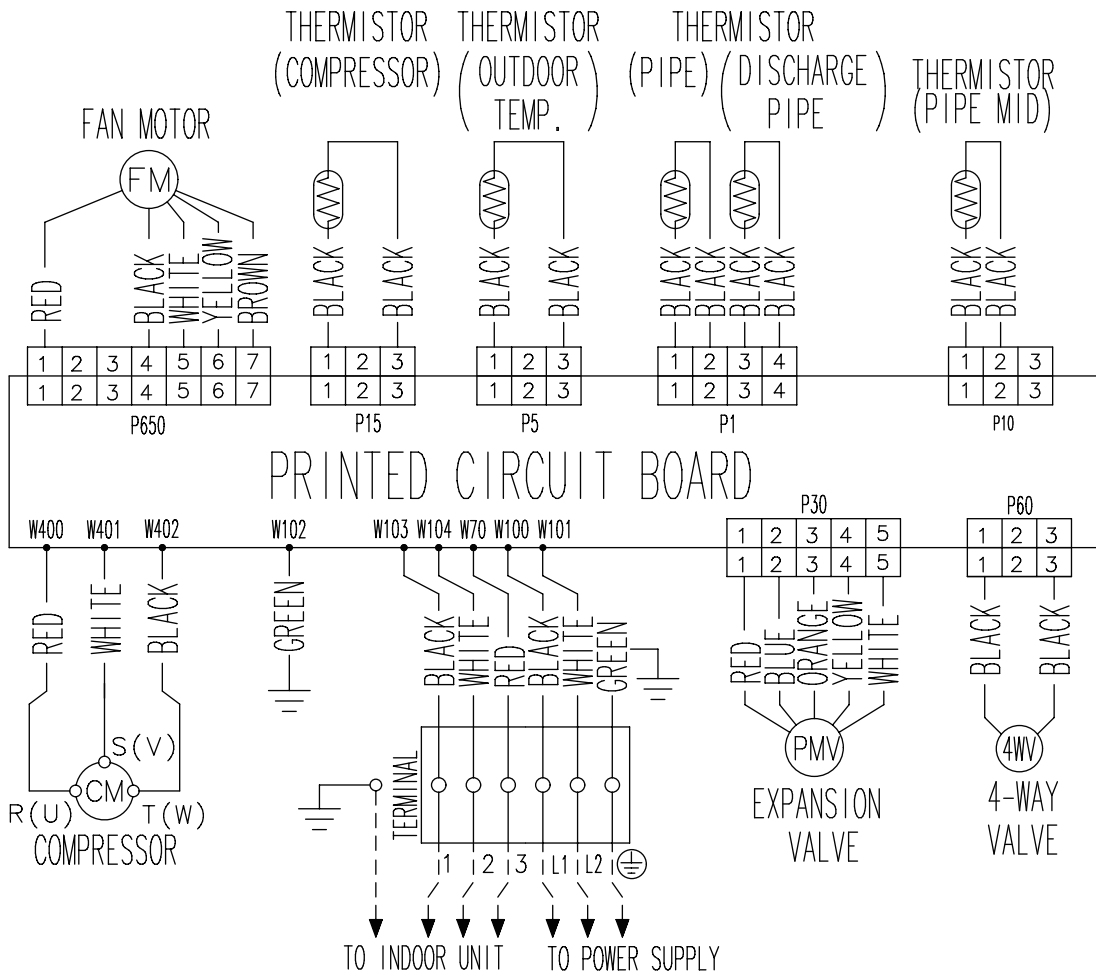

6. Capacity compensation rate for pipe length and height difference

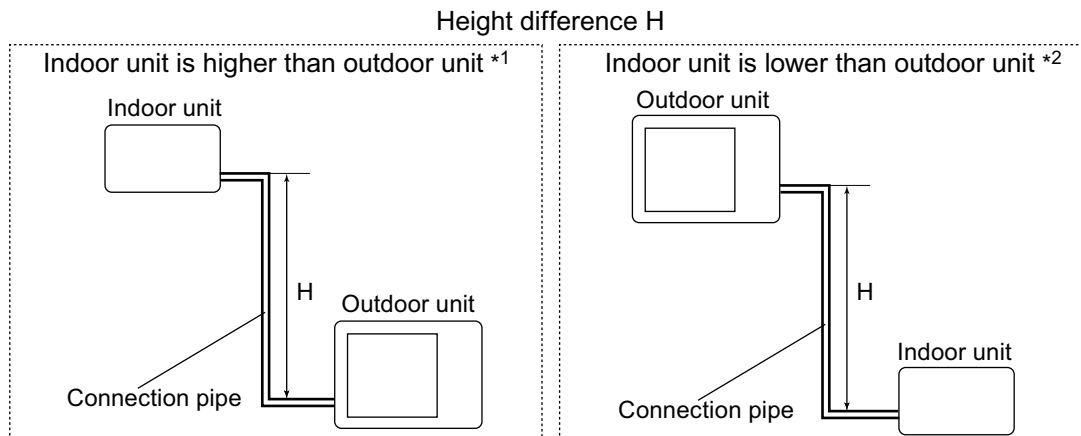

6-1. Model: AOUH09LUAS1

NOTE: Values mentioned in the table are calculated based on the maximum capacity.

COOLING		Pipe length						
		m						
			ft	5	7.5	10	15	20
Height difference H	Indoor unit is higher than outdoor unit *1	15	49	—	—	—	0.883	0.893
		10	33	—	—	0.956	0.897	0.907
		7.5	25	—	0.988	0.960	0.901	0.910
		5	16	1.021	0.992	0.964	0.904	0.915
	0	0	1.029	1.000	0.971	0.913	0.922	
Indoor unit is lower than outdoor unit *2	-5	-16	1.029	1.000	0.971	0.913	0.922	
	-7.5	-25	—	1.000	0.971	0.913	0.922	
	-10	-33	—	—	0.971	0.913	0.922	
	-15	-49	—	—	—	0.913	0.922	

HEATING		Pipe length						
		m						
			ft	5	7.5	10	15	20
Height difference H	Indoor unit is higher than outdoor unit *1	15	49	-	-	-	0.901	0.884
		10	33	-	-	0.974	0.901	0.884
		7.5	25	-	1.000	0.974	0.901	0.884
		5	16	1.006	1.000	0.974	0.901	0.884
	0	0	1.006	1.000	0.974	0.901	0.884	
Indoor unit is lower than outdoor unit *2	-5	-16	1.001	0.995	0.969	0.896	0.880	
	-7.5	-25	-	0.993	0.967	0.894	0.878	
	-10	-33	-	-	0.965	0.892	0.876	
	-15	-49	-	-	-	0.883	0.867	

6-2. Model: AOUH12LUAS1

NOTE: Values mentioned in the table are calculated based on the maximum capacity.

COOLING		Pipe length						
		m	ft	5	7.5	10	15	20
				16	25	33	49	66
Height difference H	Indoor unit is higher than outdoor unit *1	15	49	-	-	-	0.877	0.874
		10	33	-	-	0.956	0.891	0.888
		7.5	25	-	0.988	0.960	0.895	0.892
		5	16	1.017	0.992	0.964	0.899	0.895
		0	0	1.025	1.000	0.971	0.906	0.902
	Indoor unit is lower than outdoor unit *2	-5	-16	1.025	1.000	0.971	0.906	0.902
		-7.5	-25	-	1.000	0.971	0.906	0.902
		-10	-33	-	-	0.971	0.906	0.902
-15		-49	-	-	-	0.906	0.902	

HEATING		Pipe length						
		m	ft	5	7.5	10	15	20
				16	25	33	49	66
Height difference H	Indoor unit is higher than outdoor unit *1	15	49	-	-	-	0.933	0.925
		10	33	-	-	0.981	0.933	0.925
		7.5	25	-	1.000	0.981	0.933	0.925
		5	16	1.017	1.000	0.981	0.933	0.925
		0	0	1.017	1.000	0.981	0.933	0.925
	Indoor unit is lower than outdoor unit *2	-5	-16	1.012	0.995	0.976	0.928	0.920
		-7.5	-25	-	0.993	0.974	0.926	0.918
		-10	-33	-	-	0.971	0.923	0.916
-15		-49	-	-	-	0.914	0.906	

6-3. Model: AOUH18LUAS1

NOTE: Values mentioned in the table are calculated based on the maximum capacity.

COOLING		Pipe length								
		m		5	7.5	10	15	20	25	30
		ft	16	25	33	49	66	82	98	
Height difference H	Indoor unit is higher than outdoor unit *1	15	49	-	-	-	0.951	0.950	0.947	0.941
		10	33	-	-	0.979	0.967	0.966	0.962	0.956
		7.5	25	-	0.988	0.983	0.971	0.970	0.966	0.960
		5	16	0.994	0.992	0.987	0.975	0.974	0.970	0.964
	Indoor unit is lower than outdoor unit *2	0	0	1.002	1.000	0.995	0.983	0.982	0.978	0.972
		-5	-16	1.002	1.000	0.995	0.983	0.982	0.978	0.972
		-7.5	-25	-	1.000	0.995	0.983	0.982	0.978	0.972
		-10	-33	-	-	0.995	0.983	0.982	0.978	0.972
	-15	-49	-	-	-	0.983	0.982	0.978	0.972	

HEATING		Pipe length								
		m		5	7.5	10	15	20	25	30
		ft	16	25	33	49	66	82	98	
Height difference H	Indoor unit is higher than outdoor unit *1	15	49	-	-	-	0.994	0.979	0.949	0.919
		10	33	-	-	1.012	0.994	0.979	0.949	0.919
		7.5	25	-	1.000	1.012	0.994	0.979	0.949	0.919
		5	16	0.969	1.000	1.012	0.994	0.979	0.949	0.919
	Indoor unit is lower than outdoor unit *2	0	0	0.969	1.000	1.012	0.994	0.979	0.949	0.919
		-5	-16	0.964	0.995	1.007	0.989	0.974	0.944	0.915
		-7.5	-25	-	0.993	1.004	0.986	0.972	0.942	0.911
		-10	-33	-	-	1.002	0.984	0.969	0.940	0.909
	-15	-49	-	-	-	0.974	0.959	0.930	0.899	

7. Additional charge calculation

7-1. Model: AOUH09LUAS1

Refrigerant type	R410A	
Refrigerant amount	lb oz	2lbs.3oz.
	g	1,000

■ Refrigerant charge

Total pipe length	ft	49 or less	66 (Max.)	0.2 oz/ft (20 g/m)
	m	15 or less	20 (Max.)	
Additional charge	oz	0	4.0	
	g	0	100	

7-2. Model: AOUH12LUAS1

Refrigerant type	R410A	
Refrigerant amount	lb oz	2lbs.10oz.
	g	1,200

■ Refrigerant charge

Total pipe length	ft	49 or less	66 (Max.)	0.2 oz/ft (20 g/m)
	m	15 or less	20 (Max.)	
Additional charge	oz	0	4.0	
	g	0	100	

7-3. Model: AOUH18LUAS1

Refrigerant type	R410A	
Refrigerant amount	lb oz	2lbs.12oz.
	g	1,250

■ Refrigerant charge

Total pipe length	ft	66 or less	82 or less	98 (Max.)	0.2 oz/ft (20 g/m)
	m	20 or less	25 or less	30 (Max.)	
Additional charge	oz	0	4.0	7.0	
	g	0	100	200	

8. Airflow

8-1. Model: AOUH09LUAS1

● Cooling

Airflow	
m ³ /h	1,540
l/s	428
CFM	906

● Heating

Airflow	
m ³ /h	1,540
l/s	428
CFM	906

8-2. Model: AOUH12LUAS1

● Cooling

Airflow	
m ³ /h	1,990
l/s	553
CFM	1,171

● Heating

Airflow	
m ³ /h	1,850
l/s	514
CFM	1,089

8-3. Model: AOUH18LUAS1

● Cooling

Airflow	
m ³ /h	2,370
l/s	658
CFM	1,395

● Heating

Airflow	
m ³ /h	2,480
l/s	689
CFM	1,460

9. Operation noise (sound pressure)

9-1. Noise level curve

Model: AOUH09LUAS1

Cooling

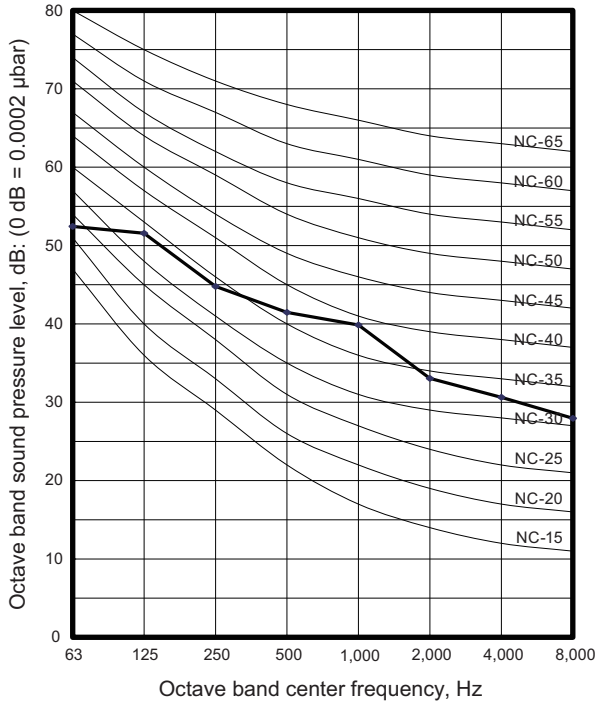

Heating

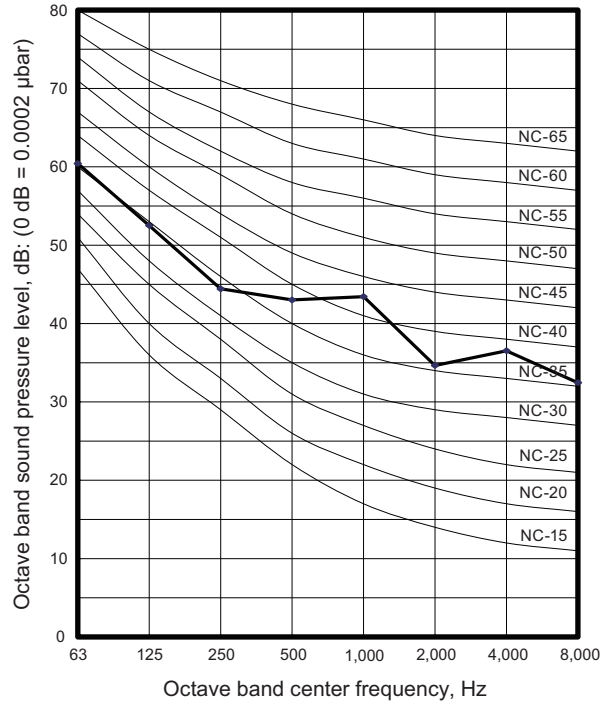

Model: AOUH12LUAS1

Cooling

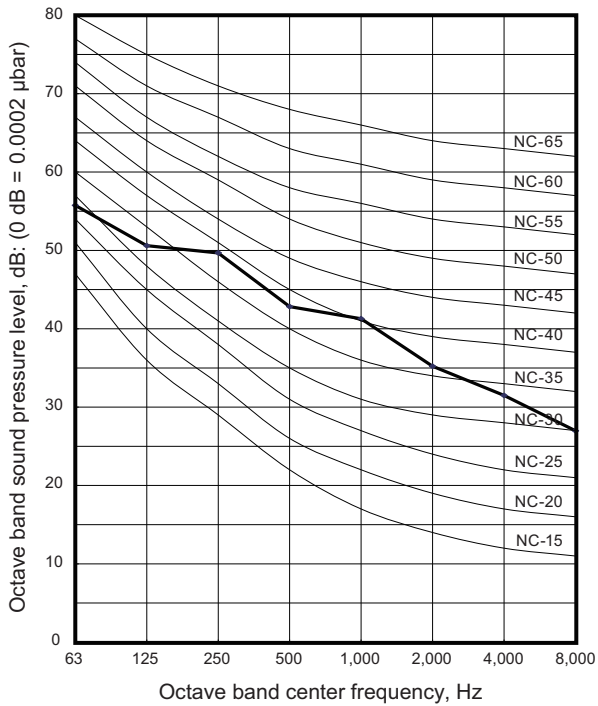

Heating

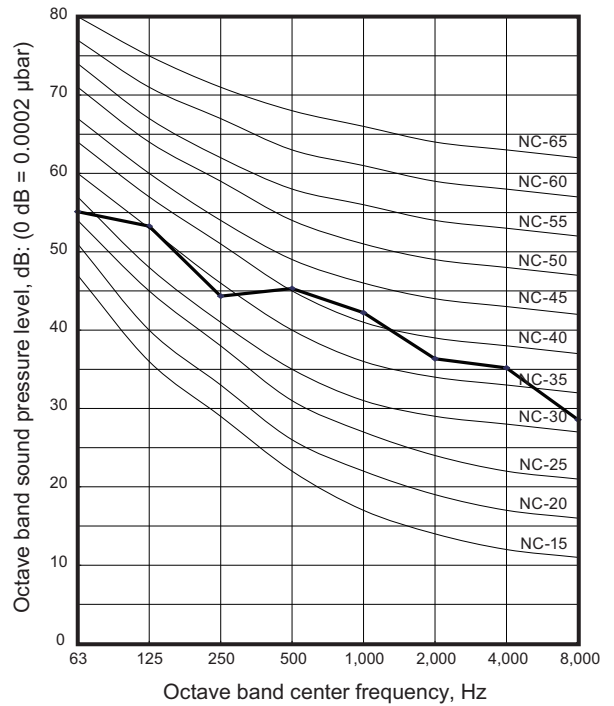

OUTDOOR UNIT
AOUH09-18LUAS1

OUTDOOR UNIT
AOUH09-18LUAS1

■ Model: AOUH18LUAS1

● Cooling

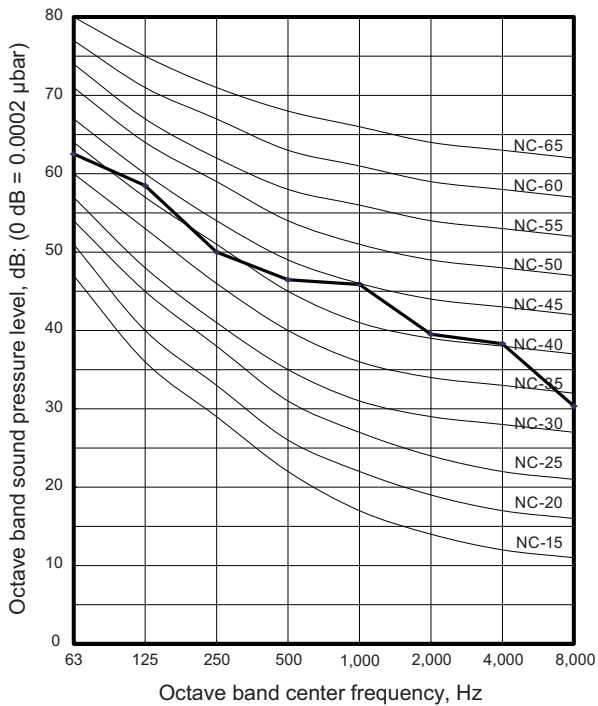

● Heating

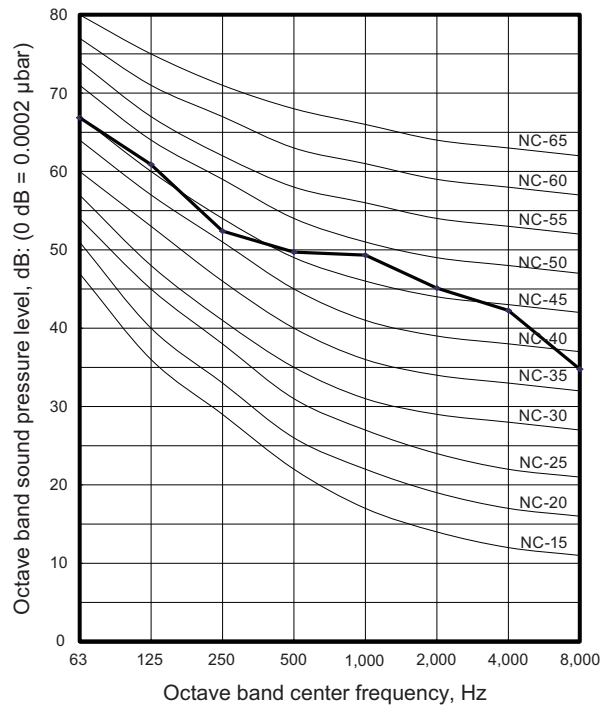

OUTDOOR UNIT
AOUH09-18LUAS1

OUTDOOR UNIT
AOUH09-18LUAS1

9-2. Sound level check point

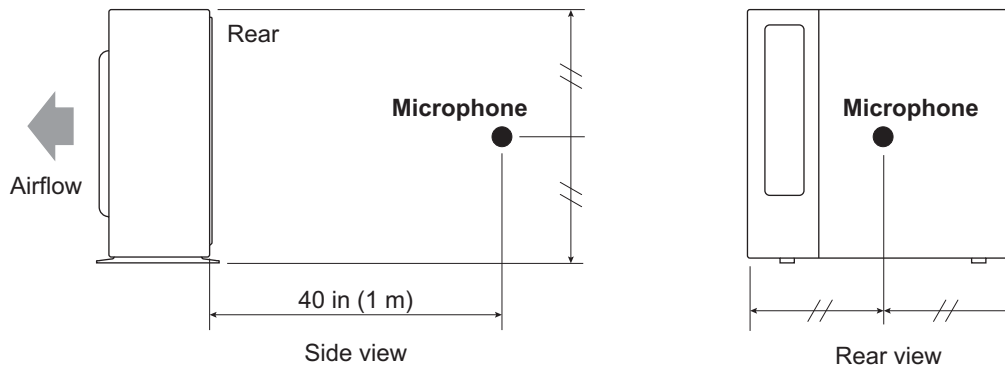

NOTE: Detailed shape of the actual outdoor unit might be slightly different from the one illustrated above.

10. Electrical characteristics

Model name			AOUH09LUAS1	AOUH12LUAS1	AOUH18LUAS1
Power supply	Voltage	V	208/230~		
	Frequency	Hz	60		
MCA *1		A	9.3	11.3	14.8
Starting current		A	4.5	5.8	7.6
Wiring spec. *2	MAX. CKT. BKR *3		A	15	20
	Power cable		AWG	14	
	Connection cable *4	Size	AWG	14	
		Limited wiring length	ft (m)	69 (21)	

*1: Minimum Circuit Ampacity (Calculation based on UL60335-2-40)

*2: Selected sample based on Japan Electrotechnical Standards and Codes Committee E0005. As the regulations of wire size and circuit breaker differ in each country or region, select appropriate devices complied to the regional standard.

*3: Maximum Circuit Breaker

*4: Limit voltage drop to less than 2%. If voltage drop is 2% or more, increase cable conductor size.

11. Safety devices

OUTDOOR UNIT
AOUH09-18LUAS1



OUTDOOR UNIT
AOUH09-18LUAS1

Type of protection	Protection form		Model	
			AOUH09LUAS1	
Circuit protection	Current fuse (Main PCB)		250 V, 15 A	
			250 V, 5 A	
			250 V, 3.15 A	
Fan motor protection	Thermal protection program	Activate	217.4±32.4 °F (103±18°C) Fan motor stop	
		Reset	203±32.4 °F or less (95±18 °C or less) Fan motor restart	
Compressor protection	Thermal protection program (Discharge temp.)	Activate	230 °F (110 °C) Compressor stop	
		Reset	After 7 minutes Compressor restart	
	Thermal protection program (Outdoor temp.) (Only in COOL or DRY mode)	Activate	5 °F (-15°C) Compressor stop	
		Reset	14 °F (-10°C) Compressor restart	

Type of protection	Protection form		Model	
			AOUH12LUAS1	AOUH18LUAS1
Circuit protection	Current fuse (Main PCB)		250 V, 15 A	250 V, 20 A
			250 V, 5 A	
			250 V, 3.15 A	
Fan motor protection	Thermal protection program	Activate	257±18 °F (125±10 °C) Fan motor stop	
		Reset	248±18 °F (120±10 °C) Fan motor restart	
Compressor protection	Thermal protection program (Compressor temp.)	Activate	226 °F (108 °C) Compressor stop	
		Reset	After 3 minutes, and 176 °F (80 °C) or less Compressor restart	
	Thermal protection program (Discharge temp.)	Activate	230 °F (110 °C) Compressor stop	
		Reset	After 7 minutes Compressor restart	
	Thermal protection program (Outdoor temp.) (Only in COOL and DRY mode)	Activate	5 °F (-15 °C) Compressor stop	
		Reset	14 °F (-10 °C) Compressor restart	

12. Accessories

12-1. Models: AOUH09LUAS1, AOUH12LUAS1, and AOUH18LUAS1

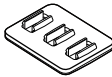
Part name	Exterior	Q'ty	Part name	Exterior	Q'ty
Installation manual		1	Cable tie		2
Drain pipe		1	Drain cap		5